

I L L U M I N A I L D E S I G N

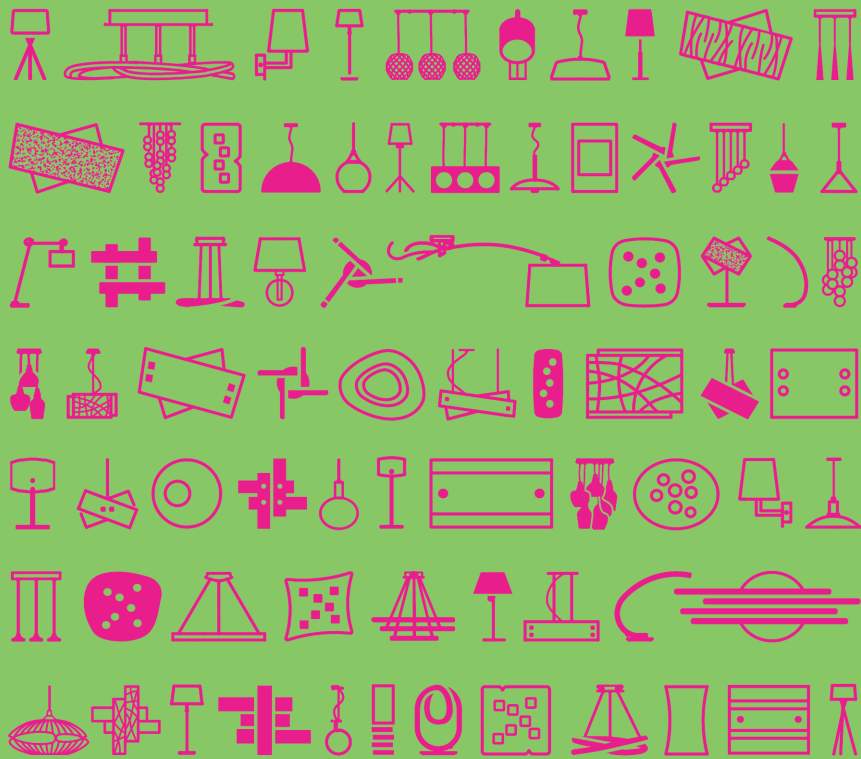

I L L U M I N A T I N G D E S I G N





1992

2020



BOOK_20**21**

GEA LUCE, technology runs in the family /

GEA LUCE, LA TECNOLOGIA È DI FAMIGLIA

Gea Luce è un'azienda con un know-how consolidato nel campo dell'illuminazione, forte di un'esperienza pluridecennale che da sempre produce apparecchi all'avanguardia, dove design, stile e tecnologia sono un tutt'uno.

Una storia di famiglia che vede uniti tre fratelli - Enrico, Antonio e Lucia - nel far crescere e consolidare un progetto comune ambizioso: la produzione di soluzioni per l'illuminazione che sfruttano le più moderne tecnologie, come quella LED, per offrire sempre la luce giusta in ogni situazione e per ogni ambiente. Un'azienda che guarda sempre al futuro e alle opportunità che questo sa regalare, un'azienda pronta a raccogliere le sfide e a trasformarle in modi nuovi di esprimere la luce /

Gea Luce is a company with well-established expertise in the lighting sector, based on decades of experience in producing cutting-edge fixtures, combining design, style and technology. A family story that brought together three brothers - Enrico, Antonio and Lucia - to develop and consolidate an ambitious joint project: the production of lighting solutions that harness the most modern technologies, such as LED technology, to create the perfect light for every situation and every environment. A company that always looks to the future and to the opportunities it offers, a company ready to face challenges and transform them into new ways of expressing light.



1992. GEA one name, one hallmark /

1992. GEA UN NOME, UN'IMPRONTA

Tre lettere che racchiudono più di trent'anni di passione, professionalità e costanza.

Un Logo che da sempre ha rappresentato la nostra comunicazione, accompagnandoci durante il nostro percorso, lasciando un'impronta nel panorama Europeo della Luce. Alle soglie del 2021, in un momento storico in cui innovazione tecnologica e digitalizzazione sono il mantra di ogni realtà aziendale,

Gea Luce abbraccia con entusiasmo il vento del cambiamento rinnovando la propria immagine /

Three letters that symbolise more than thirty years of passion, professionalism and perseverance.

A Logo that has always represented our communication, accompanying us on our journey, leaving an imprint on the European panorama of light. On the threshold of 2021, at a time when technological innovation and digitalisation are every company's mantra, Gea Luce is enthusiastically embracing the wind of change and renewing its image.

The answer to the future is innovation /

LA RISPOSTA AL FUTURO È NELL'INNOVAZIONE

La luce del futuro è in continua evoluzione. GEA LUCE ne anticipa le tendenze, rispondendo con nuove proposte e soluzioni inedite.

Alla base di ogni progetto c'è un condensato di tecnologia che soddisfa le più moderne richieste del mercato, come la riduzione dei consumi, alte prestazioni, prodotti eco sostenibili, facili da installare e dalla lunga durata. Per vivere la luce senza pensieri.

Ma modernità significa anche colore, energia e stile. Per questo le nuove linee GEA LUCE si vestono con materiali che spaziano dal metallo al vetro e abbracciano forme sempre originali, design accattivanti, dove la semplicità è sinonimo di eleganza.

GEA LUCE è prospettiva, è visione, è futuro, per darti sempre la migliore illuminazione: funzionale e con stile /

The light of the future is continuously being transformed. GEA LUCE predicts trends, presenting new proposals and unprecedented solutions.

At the base of each project lies a synthesis of technology that meets the most modern market demands, such as reduced consumption and high-performance, easy-to-install and long-lasting eco-friendly products. Experience light without a second thought.

But modernity also means colour, energy and style. This is why the new GEA LUCE product lines are equipped with materials ranging from metal to glass and always embrace original shapes and attractive designs, in which simplicity is synonymous with elegance.

GEA LUCE represents perspective, vision, and the future. We want to always bring you the best lighting that combines functionality with style.



2020. Open to new horizons /

2020. APERTI A NUOVI ORIZZONTI

GEA LUCE si rinnova, mantenendo la sua identità. Un LOGO nuovo, una nuova veste grafica, un'immagine moderna e coerente che proietta il marchio verso il futuro, simbolo dell'intesa che lega i tre fratelli in questa mission aziendale uniti dalla stessa visione dove la luce è espressione di tecnologia e stile.

Il Marchio GEA LUCE è unione ma è anche apertura al futuro, fatto di concretezza, idee semplici e forti, capaci di regalarci sempre nuove soluzioni nel mondo dell'illuminazione /

GEA LUCE renews itself and evolves while maintaining its identity.

A new LOGO, up-to-date graphics, a modern and coherent image that launches the brand towards a new frontier, a symbol of the mutual understanding that Enrico, Antonio and Lucia renew in this corporate mission, united by the same vision where lighting continues to be experienced as an expression of technology and style.

The new GEA LUCE brand represents union but also openness to the future. A future built on pragmatism, simple and strong ideas, creating a new way of experiencing light.

Suspension lamps /

LAMPADE A SOSPENSIONE



AGNESE
267



AIDA
189



AMINA
50



ANTEA
56



ASMARA
236



AURELIA
236



AZZURRA
236



BARBIE
34



BLANCA
38



BONELLA
42



BRUNA
46



CAMILLA
275

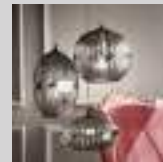

CESIRA
250



CLEOFE
226



CORA
212



DAFNE
14



DELIA
300



DIVA
70

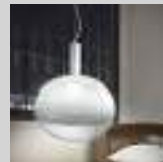

ELBA
216

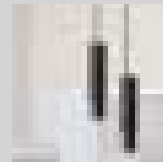

EMILY
26



ESTER
216



GISELLE
152



GUYA
20



HELENA
10



IOLE
82

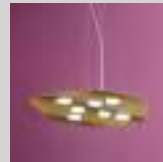

IRENE
148



ISOTTA
170



KRIZIA
62

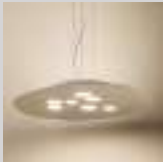

LUNA
164



NEREIDE
292



PENELOPE
258



SFERA
220



SOLE
136



YARA
76

Ceiling lamps /

LAMPADE A SOFFITTO



AGNESE
271



AIDA
188



ANTEA
60



ARIA
112



BILBAO
158



CAMILLA
276



DELIA
298



DOHA
124



DUNA
30



EMILY
28



FRIDA
286

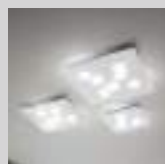

GISELLE
155

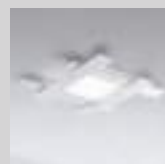

GRACE
118



IRENE
146



ISOTTA
172

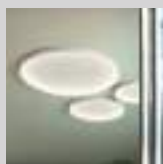

KRIZIA
66



LARA
280

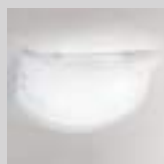

LECCE
312



LUNA
166



MANILA
108



MELANIA
104



MICHELA
308



NEREIDE
295



OLIMPIA
142



PENELOPE
260

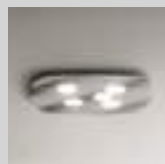

SOLE
138



TESSA
100



TOSCA
96



TULLIA
92



YARA
80

Wall lamps /

LAMPADRE A PARETE



ADELA

208



AGNESE

268

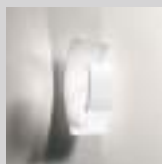

ARIA

116

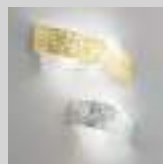

CAMILLA

278

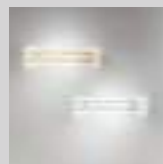

DELIA

302

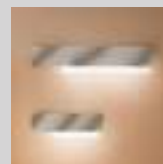

DOHA

130



FRIDA

288

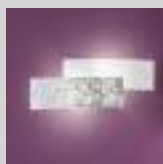

LARA

282



LECCE

310



MICHELA

307



NEREIDE

296



PENELOPE

262



TOSCA

98

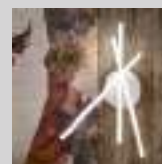

TULLIA

93

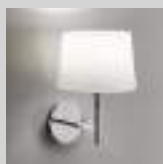

VANDA

184

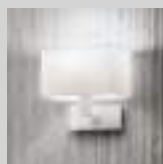

VELIA

204



VITA

196

Table lamps /

LAMPADE DA TAVOLO



AGNESE
270



CAMILLA
274

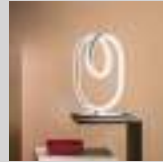

DIVA
74



IOLE
88



NEREIDE
294



PENELOPE
263



TARA
200



VANDA
184



VELIA
206



VITA
198

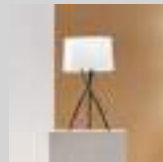

ZAIRA
177

Floor lamps /

LAMPADE DA TERRA



ADELA
209



IOLE
89



SUELO
192



TARA
200



TILDE
180

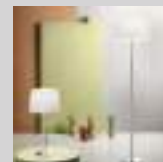

VANDA
184



VELIA
205



VITA
197



ZAIRA
176





HELENA

Sembra un piccolo Ufo con una grande anima luminosa che sicuramente saprà caratterizzare lo spazio. Semplicità e delicatezza sono i termini che meglio rappresentano questa mini serie composta da sospensione singola e reglette a 3 luci. Disponibile nei colori bianco e nero, si distingue per l'elegante e gradevole luce d'accento /

Resembling a small UFO with a large luminous core, Helena is certainly able to add character to a space. Simplicity and delicacy are the terms that best represent this mini-series composed of a single pendant lamp and a 3-light spotlight. Available in black and white, Helena stands out for its elegant and pleasant accent lighting.





TECHNICAL INFORMATION

Sospensioni con montatura in alluminio.

Finiture: bianco satinato con rosone bianco satinato;

nero satinato con rosone nero satinato;

Sorgente luminosa led /

Suspension lighting with aluminium frame.

Finishes: satin white with satin white canopy;

satin black with satin black canopy;

LED light source.

**HELENA S/1**

Socket: **1 modulo LED**

Power: **max 7W**

Input: **220/240V**

Lumen: **325Lm**

Optic: **38°**

CRI: **>90**

Light temp.: **3000°K**

Pack: **0,002 m³**

**HELENA S/3**

Socket: **3 moduli LED**

Power: **max 16,5W**

Input: **220/240V**

Lumen: **920Lm**

Optic: **38°**

CRI: **>90**

Light temp.: **3000°K**

Pack: **0,009 m³**

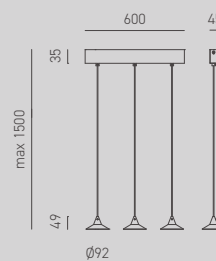

FINISHING



Bianco Satinato - Bianco Satinato
Satin White - Satin White



Nero Satinato - Nero Satinato
Satin Black - Satin Black

DAFNE

Il suo design longilineo, la luce diretta sul piano di lavoro, creano una figura perfetta, quasi naturale: minimalismo assoluto.

Disponibile in 2 misure, a sospensione singola o multipla da 3 luci in linea; è il complemento ideale per i vostri spazi grazie alla possibilità di scegliere tra le eleganti finiture bianco, nero e oro spazzolato /

Its slender design and the direct light it shines onto a work surface creates a perfect, almost natural form: absolute minimalism.

Available in 2 sizes, single or multiple pendant lamps with a row of 3 lights; the possibility to choose between the elegant white, black and brushed gold finishes makes Dafne the perfect lighting solution to complement your spaces.





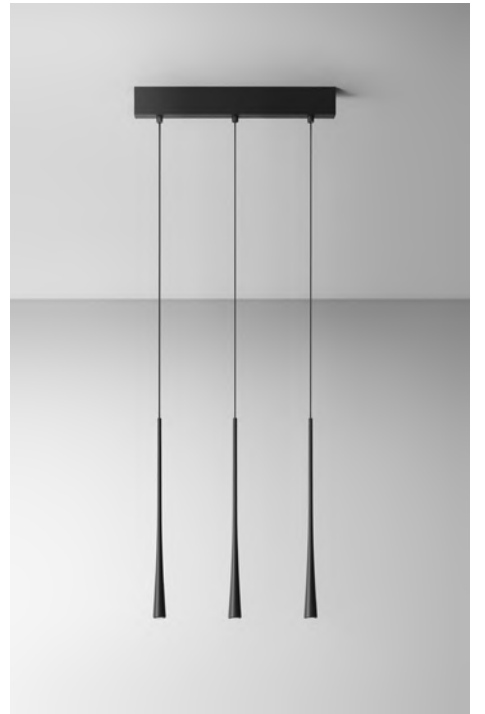





TECHNICAL INFORMATION

Sospensioni con montatura in alluminio.

Finiture: bianco satinato con rosone bianco satinato; nero satinato con rosone nero satinato; oro con rosone nero satinato. Sorgente luminosa led / Suspension lighting with aluminium frame.

Finishes: satin white with satin white canopy; satin black with satin black canopy, gold with satin black canopy. LED light source.

**DAFNE S/P**

Socket: **1 modulo LED**
 Power: **max 7W**
 Input: **220/240V**
 Lumen: **213Lm**
 Optic: **38°**
 CRI: **>90**
 Light temp.: **3000°K**
 Pack: **0,003 m³**

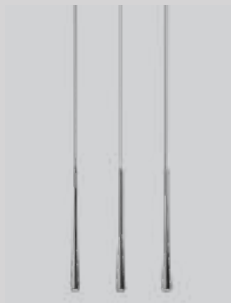
**DAFNE S/3P**

Socket: **3 moduli LED**
 Power: **max 16,5W**
 Input: **220/240V**
 Lumen: **612Lm**
 Optic: **38°**
 CRI: **>90**
 Light temp.: **3000°K**
 Pack: **0,008 m³**

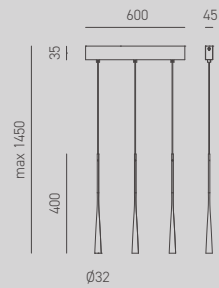
**DAFNE S/G**

Socket: **1 modulo LED**
 Power: **max 7W**
 Input: **220/240V**
 Lumen: **213Lm**
 Optic: **38°**
 CRI: **>90**
 Light temp.: **3000°K**
 Pack: **0,005 m³**

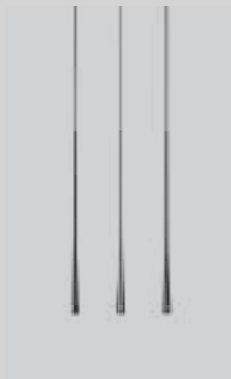
**DAFNE S/3G**

Socket: **3 moduli LED**
 Power: **max 16,5W**
 Input: **220/240V**
 Lumen: **612Lm**
 Optic: **38°**
 CRI: **>90**
 Light temp.: **3000°K**
 Pack: **0,008 m³**

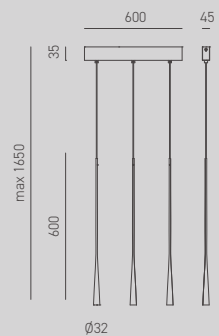

FINISHING

-  Bianco Satinato - Bianco Satinato
Satin White - Satin White
-  Nero Satinato - Nero Satinato
Satin Black - Satin Black
-  Oro - Nero Satinato
Gold - Satin Black

GUYA

Guya soddisfa ogni richiesta d'abbinamento d'arredo grazie ad un design essenziale e forme geometricamente perfette.

Declinata nelle versioni a sospensione singola, sospensione lineare da 3 luci e sospensione tonda da 5 luci, è la soluzione ideale per creare giochi di riflessi contemporanei e personalizzare gli ambienti, grazie alle finiture oro spazzolato con coprifilo nero, bianco e nero, con la montatura e il coprifilo in tinta /

Guya pairs with any decor combination required thanks to its minimalist design and geometrically perfect shapes.

Guya is available in three versions; a single pendant lamp, a 3-light linear pendant lamp and 5-light round pendant lamp. It is the ideal solution to create a contemporary play of reflections and personalise spaces, thanks to the brushed gold whit black canopy, black and white finishes, with the frame and the casing in the same colour.









TECHNICAL INFORMATION

Sospensioni con montatura in alluminio.
 Finiture: bianco satinato con rosone bianco satinato; nero satinato con rosone nero satinato; oro con rosone nero satinato. Sorgente luminosa led /
 Suspension lighting with aluminium frame. Finishes: satin white with satin white canopy; satin black with satin black canopy; gold with satin black canopy. LED light source.

**GUYA S/1**

Socket: **1 modulo LED**
 Power: **max 8,5W**
 Input: **220/240V**
 Lumen: **410Lm**
 Optic: **36°**
 CRI: **>90**
 Light temp.: **3000°K**
 Pack: **0,002 m³**

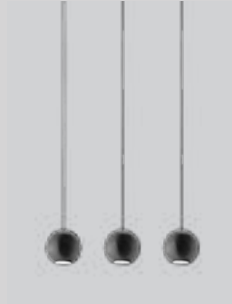
**GUYA S/3**

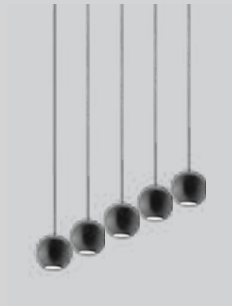
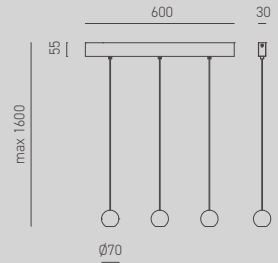

Socket: **3 moduli LED**
 Power: **max 24W**
 Input: **220/240V**
 Lumen: **1525Lm**
 Optic: **36°**
 CRI: **>90**
 Light temp.: **3000°K**
 Pack: **0,007 m³**

**GUYA S/5**

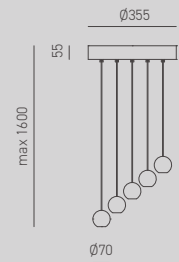
Socket: **5 moduli LED**
 Power: **max 40W**
 Input: **220/240V**
 Lumen: **2362Lm**
 Optic: **36°**
 CRI: **>90**
 Light temp.: **3000°K**
 Pack: **0,020 m³**



FINISHING

-  Bianco Satinato - Bianco Satinato
Satin White - Satin White
-  Nero Satinato - Nero Satinato
Satin Black - Satin Black
-  Oro - Nero Satinato
Gold - Satin Black



EMILY

Sono l'aspetto sobrio e incisivo a rendere Emily il prodotto versatile ideale per ogni stile di interno. Caratterizzata da un design quasi elementare, ma al contempo accurato nei particolari tagli a laser, si propone come sospensione o come piccola plafoniera, nei colori nero e bianco. Il fascio di luce emesso dalla sorgente luminosa viene sapientemente filtrato dal diffusore opalino, rendendolo confortevole anche alla vista diretta / Emily's understated and incisive look makes this versatile product ideal for any interior style. While an almost elementary design characterises Emily, it also features accurate laser-cut details at the same time. It is proposed as a pendant lamp or as a small ceiling lamp, in black and white. The beam of light emitted by the light source is expertly filtered by the opal diffuser, ensuring eye comfort even when it is in direct view.

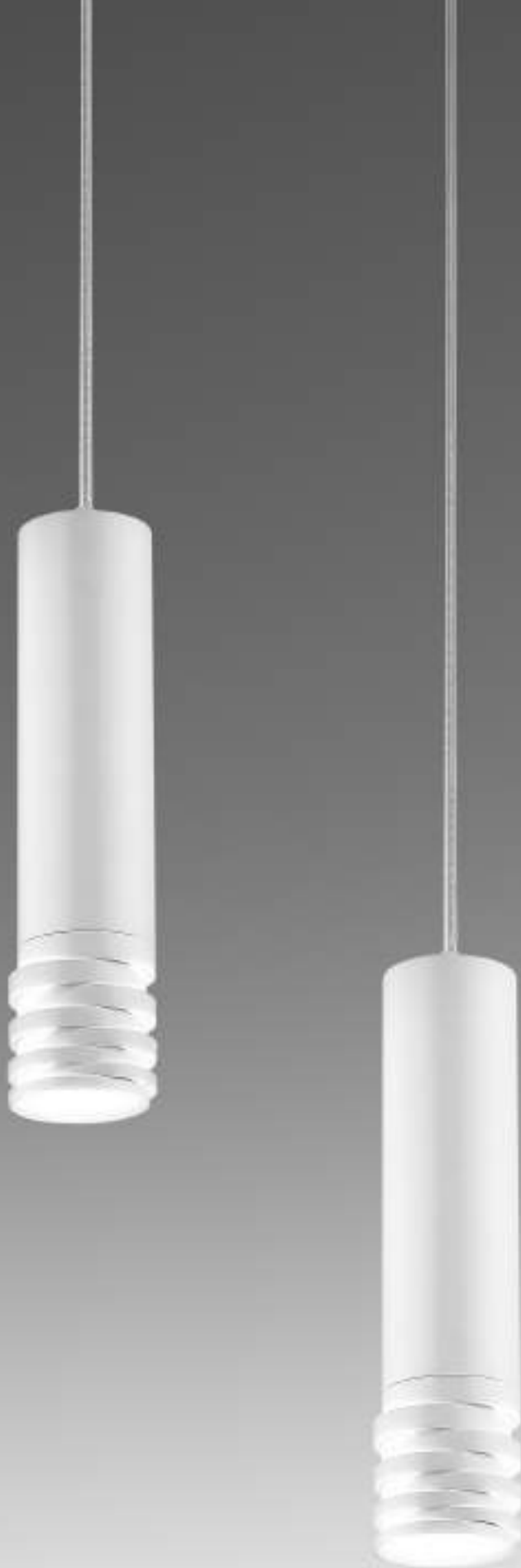



TECHNICAL INFORMATION

Montatura in metallo satinato bianco
o satinato nero.
Diffusore in acrilico.
Lampadina non inclusa./
Satin white or satin black metal frame.
Acrylic diffuser.
Bulb not included.

**EMILY P**



Socket: **1xGU10**
Power: **max 35W**
Input: **220/240V**
Pack: **0,002 m³**

**EMILY S**

Socket: **1xGU10**
Power: **max 35W**
Input: **220/240V**
Pack: **0,003 m³**



FINISHING

-  Bianco / White
-  Nero / Black



DUNA

La forma cilindrica ammorbidita ai fianchi determina la fine estetica di questo prodotto, realizzato con un ricercato composto cementizio in colori che richiamano la terra quali il granito grigio chiaro o grigio scuro e la pietra rossa, come se fosse stato disegnato dal caldo vento del deserto. Il design di Duna è puro essenzialismo ispirato dalle forme presenti in natura /

The cylindrical shape softened at the sides determines the refined aesthetic of this product. Duna is made with a sophisticated cementitious compound in earthy colours, such as pale or dark grey granite and red stone, as if designed by the hot desert wind. Duna's design expresses pure essentialism, drawing inspiration from forms found in nature.





TECHNICAL INFORMATION



Plafone con montatura in cemento.
 Finitura grigio chiaro, grigio scuro
 o rosso. Lampadina non inclusa./
 Ceiling lamp with concrete frame.
 Light grey, dark grey
 or red finish.
 Bulb not included.

**DUNA P**

Socket: **1xGu10**
 Power: **max 35W**
 Input: **220/240V**
 Pack: **0,002 m³**



FINISHING

-  Grigio chiaro / Light grey
-  Grigio scuro / Dark grey
-  Rosso / Red



BARBIE

Forme intuitive e conosciute che si accompagnano perfettamente a qualunque ambiente, classico o moderno. Disponibile nelle finiture ottone, rame spazzolato e nei colori bianco e nero, Barbie è il complemento perfetto per la vostra casa /

Intuitive and easily recognisable shapes that perfectly match any space, classic or modern. Available in brass, brushed copper and black and white finishes, Barbie is the perfect complement to your home.





TECHNICAL INFORMATION

Sospensione con montatura in alluminio.

Finiture: Bianco opaco esterno/bianco opaco interno, rosone bianco.

Nero opaco esterno/bianco opaco interno, rosone nero opaco.

Ottone esterno/bianco opaco interno, rosone ottone.

Rame esterno/bianco opaco interno, rosone rame.

Lampadina non inclusa/

Suspension lighting with aluminium frame.

Finishes: Matt white outside/matt white inside, matt white canopy.

Matt black outside/matt white inside, matt black canopy.

Brass outside/matt white inside brass canopy.

Copper outside/matt white inside, copper canopy.

Bulb not included.

**BARBIE S/P**



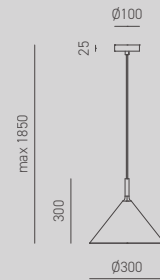

Socket: **1xE27**
 Power: **max 60W**
 Input: **220/240V**
 Pack: **0,037 m³**

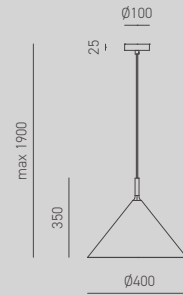
**BARBIE S/G**

Socket: **1xE27**
 Power: **max 60W**
 Input: **220/240V**
 Pack: **0,073 m³**



FINISHING

-  Bianco-Bianco / White-White
-  Nero-Bianco / Black-White
-  Ottone-Bianco / Brass-White
-  Rame-Bianco / Copper-White

BLANCA

Una linea sempre attuale, un design che esprime carattere, uniti alla funzionalità e al comfort visivo grazie alla colorazione bianca della sezione interna.

A completare questo armonioso prodotto, la scelta di finiture ricercate come il nickel e l'ottone spazzolato unitamente al bianco e al nero opaco /

Blanca's timeless lines and its design that expresses character are combined with functionality and visual comfort thanks to the white colouring of the internal section.

This harmonious product is available in a choice of sophisticated finishes such as nickel and brushed brass together with white and matt black.







TECHNICAL INFORMATION

Sospensione con montatura in alluminio.

Finiture: Bianco opaco esterno/bianco opaco interno, rosone bianco opaco.

Nero opaco esterno/bianco opaco interno, rosone nero opaco. Ottone esterno/bianco opaco interno, rosone ottone.

Nickel esterno/bianco opaco interno, rosone nickel. Lampadina non inclusa/

Suspension lighting with aluminium frame. Finishes: Matt white outside/matt white inside, matt white canopy.

Matt black outside/matt white inside, matt black canopy. Brass outside/matt white inside, brass canopy. Nickel outside/matt white inside, nickel canopy.



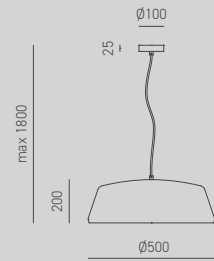

Bulb not included.

**BLANCA S/P**

Socket: **1xE27**
 Power: **max 60W**
 Input: **220/240V**
 Pack: **0,076 m³**



FINISHING

-  Bianco-Bianco / White-White
-  Nero-Bianco / Black-White
-  Ottone-Bianco / Brass-White
-  Nickel-Bianco / Nickel-White



BONELLA

Caratterizzata da un'accurata lavorazione a tornio, Bonella è la lampada a sospensione dalle dimensioni generose che si distingue per la sua raffinatezza. Grazie al suo interno verniciato bianco propone un gradevolissimo chiarore, arredando ogni ambiente con naturalezza per merito dei due diametri proposti e delle sue finiture: ottone e rame spazzolato oppure verniciato bianco o nero / Characterised by an accurate lathe technique, Bonella is a pendant lamp with generous dimensions that stands out for its elegance. It offers a charming glow thanks to its white painted interior, and the two diameters available furnish any environment with a natural quality. Bonella is available in a choice of finishes: brass and brushed copper or painted white or black.





TECHNICAL INFORMATION

Sospensione con montatura in alluminio.
 Finiture: Bianco opaco esterno/bianco opaco interno, rosone bianco opaco.
 Nero opaco esterno/bianco opaco interno, rosone nero opaco. Ottone esterno/bianco opaco interno, rosone ottone.
 Rame esterno/bianco opaco interno, rosone rame.
 Lampadina non inclusa/
 Suspension lighting with aluminium frame.

Finishes: Matt white outside/matt white inside, matt white canopy.
 Matt black outside/matt white inside, matt black canopy.
 Brass outside/matt white inside, brass canopy. Copper outside/matt white inside, copper canopy.
 Bulb not included.

**BONELLA S/P**



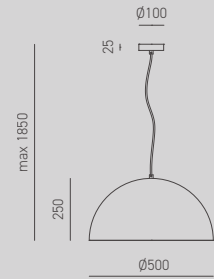

Socket: **1xE27**
 Power: **max 60W**
 Input: **220/240V**
 Pack: **0,091 m³**

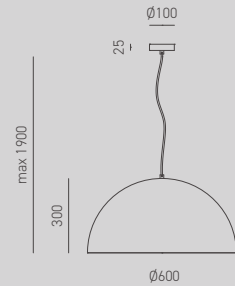
**BONELLA S/G**

Socket: **1xE27**
 Power: **max 60W**
 Input: **220/240V**
 Pack: **0,148 m³**



FINISHING

-  Bianco-Bianco / White-White
-  Nero-Bianco / Black-White
-  Ottone-Bianco / Brass-White
-  Rame-Bianco / Copper-White





BRUNA

Il design elegante e semplice dove la cura del dettaglio estremo arreda ogni ambiente con eleganza e semplicità.

Da questo concept nascono le due proposte con verniciatura esterna nero opaco e interna oro, ideale per creare emozionanti atmosfere, e la bianca con interno color nickel, perfetta per ravvivare l'ambiente.

Rifinite con portalampada in tinta esprimono un elevato e ricercato standard qualitativo / The extreme attention to detail of the clean and refined design furnishes any environment with elegance and simplicity.

This concept has inspired two products, one featuring a painted matt black exterior and gold interior which is ideal for creating breathtaking atmospheres, the other in white with nickel interior is perfect for invigorating a space. Finished with a matching lamp holder, Bruna expresses a superior and sophisticated quality standard.





TECHNICAL INFORMATION

Sospensione con montatura in alluminio.

Finiture: Bianco opaco esterno/nickel opaco interno, rosone bianco opaco.

Nero opaco esterno/oro opaco interno, rosone nero opaco.

Lampadina non inclusa/

Suspension lighting with aluminium frame. Finishes: Matt white outside/matt nickel inside, matt white canopy.

Matt black outside/matt gold inside, matt black canopy.

Bulb not included.

**BRUNA S/P**

Socket: **1xE27**
 Power: **max 60W**
 Input: **220/240V**
 Pack: **0,023 m³**

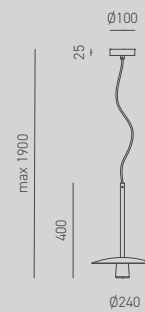
**BRUNA S/G**

Socket: **1xE27**
 Power: **max 60W**
 Input: **220/240V**
 Pack: **0,050 m³**

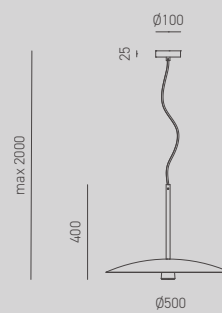

FINISHING

 Bianco-Nickel / White-Nickel

 Nero-Oro / Black-Gold

AMINA

Progettata come sospensione singola in 3 dimensioni o multipla con 2 soluzioni: base tonda o reglette lineare entrambe a 3 luci.

Amina rappresenta una scelta di stile inconfondibile.

Disegnata da mille sfaccettature che contengono, e allo stesso tempo rilasciano, una luce affascinante e confortevole è il perfetto tocco di classe per dar vita alla vostra casa /

Designed as a single pendant lamp in 3 dimensions and as a multiple pendant lamp with 2 solutions: a round or linear base, both featuring 3 lights.

Amina represents a distinct stylistic choice.

Designed with a thousand facets that contain, and at the same time release, a charming and cosy glow that makes Amina the perfect touch of class to enliven your home.









TECHNICAL INFORMATION

Sospensioni con montatura in ferro.
 Finiture in bianco ossidato, nero ossidato
 o oro ossidato con rosone in tinta.
 Lampadine non incluse/
 Suspension lighting with iron frame.
 Finishes in oxidised white, oxidised black
 or oxidised gold with matching canopy.
 Bulbs not included.

**AMINA S/P**

Socket: **1xE27**
 Power: **max 40W**
 Input: **220/240V**
 Pack: **0,013 m³**

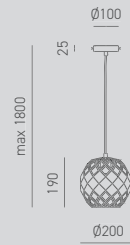
**AMINA S/M**

Socket: **1xE27**
 Power: **max 40W**
 Input: **220/240V**
 Pack: **0,034 m³**

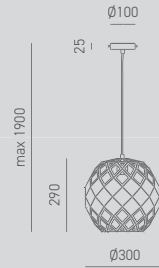
**AMINA S/G**

Socket: **1xE27**
 Power: **max 40W**
 Input: **220/240V**
 Pack: **0,078 m³**

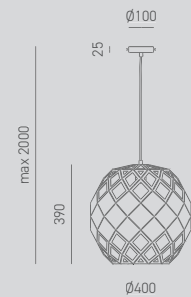
**AMINA S/T**

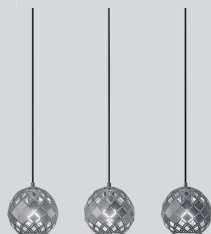
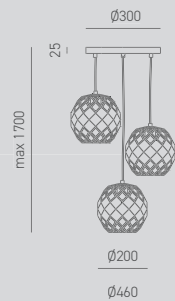

Socket: **3xE27**
 Power: **max 3x40W**
 Input: **220/240V**
 Pack: **0,066 m³**

**AMINA S/R**

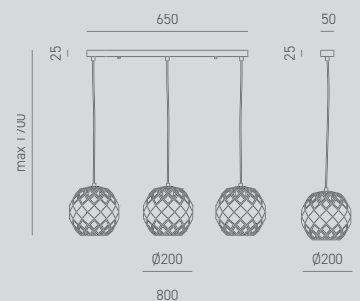
Socket: **3xE27**
 Power: **max 3x40W**
 Input: **220/240V**
 Pack: **0,052 m³**



FINISHING

-  Bianco ossidato / White oxidised
-  Nero ossidato / Black oxidised
-  Oro ossidato / Gold oxidised



ANTEA

Contrapposizione tra rigide linee perimetrali e forme circolari interne: il design minimale di Antea garantisce a questa mini serie di adattarsi ad ogni contesto, moderno o classico che sia, incorniciando la luce in uno spazio ben delimitato, eliminando qualsiasi elemento esteriore superfluo. I diffusori in vetro borosilicato soffiato consentono una luminosità esemplare /

Antea features a contrast between rigid contour lines and internal circular shapes. Its minimal design guarantees that this mini-series will adapt to any context, whether modern or classic, framing the light in a well-defined space and eliminating any superfluous external elements. The borosilicate blown glass diffusers create exemplary luminosity.









TECHNICAL INFORMATION

Montatura in ferro.

Finiture: Bianco opaco con diffusore
in vetro bianco opale;

Oro opaco con diffusore in vetro
trasparente ambrato.

Lampadine non incluse. Misura massima
della lampadina diam. 19 mm /

Ceiling lights with iron frame.

Finishes: Matt white with opal white
glass diffuser;

Matt gold with transparent amber
glass diffuser.

Bulbs not included. Maximum
bulb size 19 mm diameter.

**ANTEA P/1**

Socket: **1xG9**
Power: **max 25W**
Input: **220/240V**
Pack: **0,010 m³**

**ANTEA P/3**

Socket: **3xG9**
Power: **max 3x25W**
Input: **220/240V**
Pack: **0,025 m³**

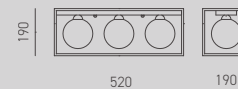
**ANTEA S/1**

Socket: **1xG9**
Power: **max 25W**
Input: **220/240V**
Pack: **0,011 m³**

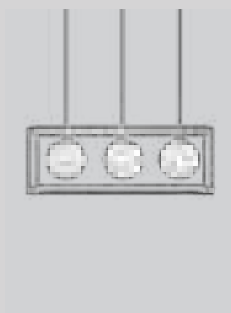
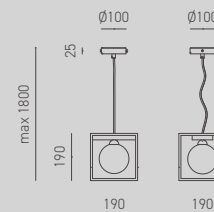
**ANTEA S/3**

Socket: **3xG9**
Power: **max 3x25W**
Input: **220/240V**
Pack: **0,028 m³**

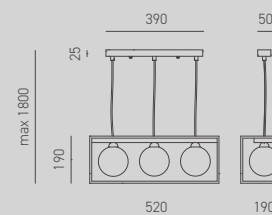

FINISHING



Bianco Opaco / Matt white
Bianco Opale / Opal White



Oro Opaco / Matt Gold
Trasparente Ambrato / Transparent Amber



KRIZIA

Geometrie perfette, composte da una serie di punti led equidistanti da un centro, completamente avvolti da una particolare struttura in alluminio parzialmente rivestita da un diffusore in acrilico bianco opalino. Cerchi metallici dalla spettacolare resa luminosa, disponibili a sospensione e a plafoniera nei diametri da 78, 58, 48 e 38 cm / Perfect geometries, composed of a series of LED light points that are equidistant from the centre, completely enveloped by a unique aluminium structure that is partially covered by a white opal acrylic diffuser. These metallic circles feature a spectacular light output and are available as pendant and ceiling lamps in diameters of 78, 58, 48 and 38 cm.











TECHNICAL INFORMATION

Montatura in alluminio satinato bianco o oro spazzolato.

Diffusore in acrilico bianco opale.

Sorgente luminosa led dimmerabile (Push) /

Frame in satin white or brushed gold aluminium. Opal white acrylic diffuser. Dimmable led light source (Push)

**KRIZIA S/P Bianco**

Socket: **1 modulo LED**
 Power: **max 38W**
 Input: **220/240V**
 Lumen: **2300Lm**
 CRI: **>80**
 Light temp.: **3000°K**
 Pack: **0,026 m³**

KRIZIA S/P Oro

Socket: **1 modulo LED**
 Power: **max 38W**
 Input: **220/240V**
 Lumen: **2200Lm**
 CRI: **>80**
 Light temp.: **3000°K**
 Pack: **0,026 m³**

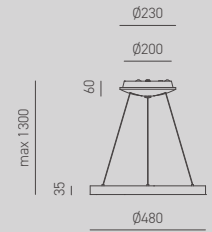
**KRIZIA S/M Bianco**

Socket: **1 modulo LED**
 Power: **max 50W**
 Input: **220/240V**
 Lumen: **2900Lm**
 CRI: **>80**
 Light temp.: **3000°K**
 Pack: **0,038 m³**

KRIZIA S/M Oro

Socket: **1 modulo LED**
 Power: **max 50W**
 Input: **220/240V**
 Lumen: **2800Lm**
 CRI: **>80**
 Light temp.: **3000°K**
 Pack: **0,038 m³**

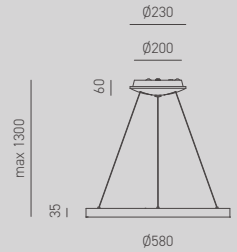
**KRIZIA S/G Bianco**

Socket: **1 modulo LED**
 Power: **max 60W**
 Input: **220/240V**
 Lumen: **4800Lm**
 CRI: **>80**
 Light temp.: **3000°K**
 Pack: **0,064 m³**

KRIZIA S/G Oro

Socket: **1 modulo LED**
 Power: **max 60W**
 Input: **220/240V**
 Lumen: **4600Lm**
 CRI: **>80**
 Light temp.: **3000°K**
 Pack: **0,064 m³**

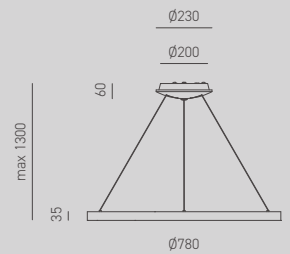
**KRIZIA S/2 Bianco**

Socket: **2 moduli LED**
 Power: **max 38W+
50W=88W**
 Input: **220/240V**
 Lumen: **6300Lm**
 CRI: **>80**
 Light temp.: **3000°K**
 Pack: **0,038 m³**

KRIZIA S/2 Oro

Socket: **2 moduli LED**
 Power: **max 38W+
50W=88W**
 Input: **220/240V**
 Lumen: **6000Lm**
 CRI: **>80**
 Light temp.: **3000°K**
 Pack: **0,038 m³**

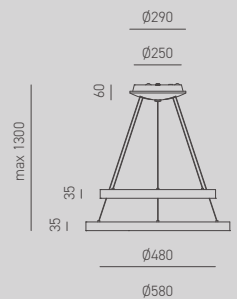

FINISHING

 Bianco / White

 Oro Spazzolato / Brushed Gold

**KRIZIA P/P Bianco**

Socket: **1 modulo LED**
 Power: **max 30W**
 Input: **220/240V**
 Lumen: **2600Lm**
 CRI: **>80**
 Light temp.: **3000°K**
 Pack: **0,015 m³**

KRIZIA P/P Oro

Socket: **1 modulo LED**
 Power: **max 30W**
 Input: **220/240V**
 Lumen: **2500Lm**
 CRI: **>80**
 Light temp.: **3000°K**
 Pack: **0,015 m³**

**KRIZIA P/M Bianco**

Socket: **1 modulo LED**
 Power: **max 38W**
 Input: **220/240V**
 Lumen: **3300Lm**
 CRI: **>80**
 Light temp.: **3000°K**
 Pack: **0,023 m³**

KRIZIA P/M Oro

Socket: **1 modulo LED**
 Power: **max 38W**
 Input: **220/240V**
 Lumen: **3200Lm**
 CRI: **>80**
 Light temp.: **3000°K**
 Pack: **0,023 m³**

**KRIZIA P/G Bianco**

Socket: **1 modulo LED**
 Power: **max 50W**
 Input: **220/240V**
 Lumen: **4100Lm**
 CRI: **>80**
 Light temp.: **3000°K**
 Pack: **0,033 m³**

KRIZIA P/G Oro

Socket: **1 modulo LED**
 Power: **max 50W**
 Input: **220/240V**
 Lumen: **4000Lm**
 CRI: **>80**
 Light temp.: **3000°K**
 Pack: **0,033 m³**

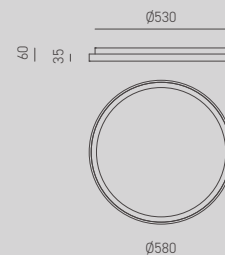
**KRIZIA P/S Bianco**

Socket: **1 modulo LED**
 Power: **max 60W**
 Input: **220/240V**
 Lumen: **5300Lm**
 CRI: **>80**
 Light temp.: **3000°K**
 Pack: **0,057 m³**

KRIZIA P/S Oro

Socket: **1 modulo LED**
 Power: **max 60W**
 Input: **220/240V**
 Lumen: **5100Lm**
 CRI: **>80**
 Light temp.: **3000°K**
 Pack: **0,057 m³**

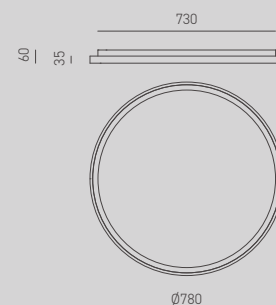



DIVA

Materia leggera, figura ariosa, linee armoniose. Diva è autentico design dettato dalla sua forma organica, che dà vita a un percorso di luce avvolgente e virtuoso. Disponibile nelle due eleganti finiture oro satinato e bianco è la soluzione ideale per ambienti di carattere /

Lightweight material, airy silhouette, harmonious lines.

Diva is an authentic design dictated by its organic form, which creates an enveloping and virtuous path of light. Available in two elegant finishes, satin gold and white, it is the ideal solution for spaces full of character.







TECHNICAL INFORMATION

Montatura in alluminio satinato bianco o oro spazzolato.
 Diffusore in silicone bianco opale.
 Sorgente luminosa led dimmerabile (Push)./
 Frame in satin white or brushed gold aluminium.
 Opal white silicone diffuser.
 Dimmable led light source (Push).

**DIVA S/P**

Socket: **1 modulo LED**
 Power: **max 39W**
 Input: **220/240V**
 Lumen: **1950Lm**
 CRI: **>80**
 Light temp.: **3000°K**
 Pack: **0,051 m³**

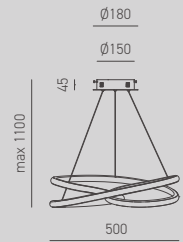
**DIVA S/G**

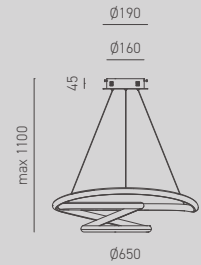

Socket: **1 modulo LED**
 Power: **max 47W**
 Input: **220/240V**
 Lumen: **2350Lm**
 CRI: **>80**
 Light temp.: **3000°K**
 Pack: **0,099 m³**

**DIVA L**

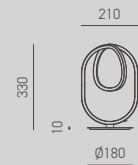
Socket: **1 modulo LED**
 Power: **max 17W**
 Input: **220/240V**
 Lumen: **680Lm**
 CRI: **>80**
 Light temp.: **3000°K**
 Pack: **0,038 m³**



FINISHING

-  Bianco / White
-  Oro Spazzolato / Brushed Gold



YARA

Ispirata agli anelli planetari che ruotano attorno a Saturno, Yara è un costante rincorrersi di linee sinuose, curve precise e regolari che creano forme perfette. La particolare luce led continua, interna ed esterna al profilo della struttura, amplifica la resa luminosa evidenziando il design avveniristico di questo intrigante prodotto. Futurismo e funzionalità / Inspired by the planetary rings that rotate around Saturn, Yara is a constant succession of sinuous lines and precise, regular curves that create perfect shapes. The special constant LED light, inside and outside the profile of the structure, amplifies the light output, highlighting the futuristic design of this intriguing product. Functional futurism.









TECHNICAL INFORMATION

Montatura in alluminio satinato bianco.
 Diffusore in silicone bianco opale.
 Sorgente luminosa led dimmerabile
 (Push) /
 Frame in satin white, opal white silicone
 diffuser. Dimmable led light
 source (Push).

**YARA P/P C**

Socket: **1 modulo LED**
 Power: **max 30W**
 Input: **220/240V**
 Lumen: **1300Lm**
 CRI: **>80**
 Light temp.: **3000°K**
 Pack: **0,073 m³**

YARA P/P N

Socket: **1 modulo LED**
 Power: **max 30W**
 Input: **220/240V**
 Lumen: **1400Lm**
 CRI: **>80**
 Light temp.: **4000°K**
 Pack: **0,073 m³**

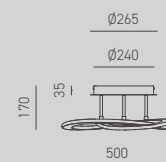
**YARA P/M C**

Socket: **1 modulo LED**
 Power: **max 40W**
 Input: **220/240V**
 Lumen: **1900Lm**
 CRI: **>80**
 Light temp.: **3000°K**
 Pack: **0,101 m³**

YARA P/M N

Socket: **1 modulo LED**
 Power: **max 40W**
 Input: **220/240V**
 Lumen: **2000Lm**
 CRI: **>80**
 Light temp.: **4000°K**
 Pack: **0,101 m³**

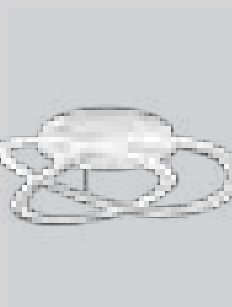
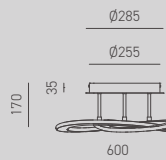
**YARA P/G C**

Socket: **1 modulo LED**
 Power: **max 50W**
 Input: **220/240V**
 Lumen: **2400Lm**
 CRI: **>80**
 Light temp.: **3000°K**
 Pack: **0,133 m³**

YARA P/G N

Socket: **1 modulo LED**
 Power: **max 50W**
 Input: **220/240V**
 Lumen: **2500Lm**
 CRI: **>80**
 Light temp.: **4000°K**
 Pack: **0,133 m³**

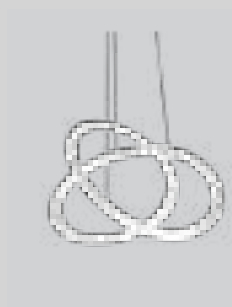
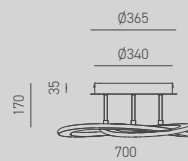
**YARA S/P C**

Socket: **1 modulo LED**
 Power: **max 40W**
 Input: **220/240V**
 Lumen: **1900Lm**
 CRI: **>80**
 Light temp.: **3000°K**
 Pack: **0,070 m³**

YARA S/P N

Socket: **1 modulo LED**
 Power: **max 40W**
 Input: **220/240V**
 Lumen: **2000Lm**
 CRI: **>80**
 Light temp.: **4000°K**
 Pack: **0,070 m³**

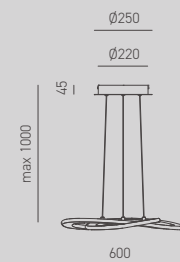
**YARA S/G C**

Socket: **1 modulo LED**
 Power: **max 50W**
 Input: **220/240V**
 Lumen: **2400Lm**
 CRI: **>80**
 Light temp.: **3000°K**
 Pack: **0,092 m³**

YARA S/G N

Socket: **1 modulo LED**
 Power: **max 50W**
 Input: **220/240V**
 Lumen: **2500Lm**
 CRI: **>80**
 Light temp.: **4000°K**
 Pack: **0,092 m³**

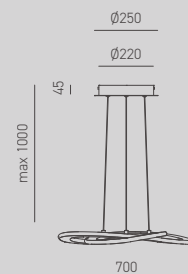

FINISHING

 Bianco Satinato / Satin White

IOLE

Creatività pura e infiniti giochi di luce. Disegnerete voi stessi la composizione che più rispetta la vostra personalità grazie alle sospensioni con elementi singoli, doppi o tripli, inclinati o meno: Iole saprà stupire i vostri ospiti per l'elegante conformazione di ogni vostra combinazione, che risulterà certamente esclusiva nella sua originalità. A completare la serie le fantastiche versioni lampada da terra e da appoggio /

Pure creativity and the infinite play of light. The pendant lamps with single, double or triple elements, that are sloped or straight, allow you to design the composition that best respects your personality. Iole will amaze your guests thanks to the elegant shape of each of your combinations, which will certainly be exclusive in their originality. The fantastic floor and table lamp versions complete the series.

















TECHNICAL INFORMATION

Montatura in alluminio satinato bianco o oro spazzolato.
 Diffusore in silicone bianco opale.
 Sorgente luminosa led dimmerabile (Push)./
 Frame in satin white
 or brushed gold aluminium.
 Opal white silicone diffuser.
 Dimmable led light source (Push).

**IOLE S/1**

Socket: **1 modulo LED**
 Power: **max 28W**
 Input: **220/240V**
 Lumen: **1400Lm**
 CRI: **>80**
 Light temp.: **3000°K**
 Pack: **0,058 m³**

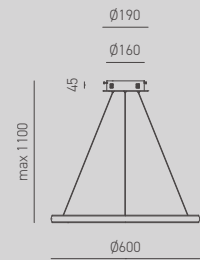
**IOLE S/2**

Socket: **2 moduli LED**
 Power: **max 40W**
 Input: **220/240V**
 Lumen: **2000Lm**
 CRI: **>80**
 Light temp.: **3000°K**
 Pack: **0,075 m³**

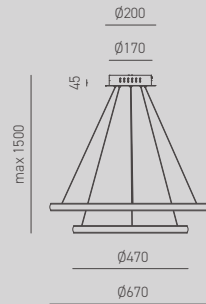
**IOLE S/3**

Socket: **3 moduli LED**
 Power: **max 60W**
 Input: **220/240V**
 Lumen: **3000Lm**
 CRI: **>80**
 Light temp.: **3000°K**
 Pack: **0,103 m³**

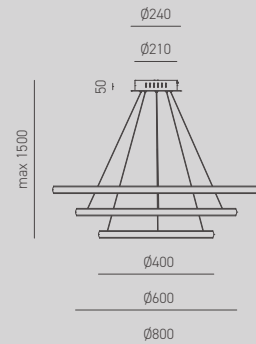

FINISHING



Bianco / White



Oro Spazzolato / Brushed Gold



IOLE L

Socket: **1 modulo LED**
 Power: **max 12W**
 Input: **220/240V**
 Lumen: **600Lm**
 CRI: **>80**
 Light temp.: **3000°K**
 Pack: **0,054 m³**

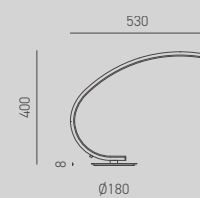

IOLE PT

Socket: **1 modulo LED**
 Power: **max 30W**
 Input: **220/240V**
 Lumen: **1500Lm**
 CRI: **>80**
 Light temp.: **3000°K**
 Pack: **0,142 m³**

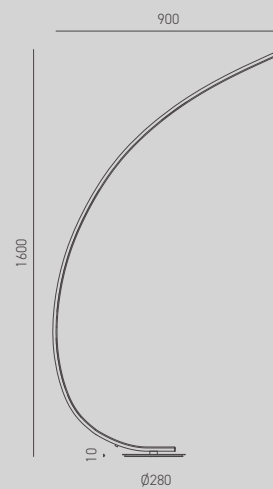



TULLIA

Tullia è la lampada da soffitto e da parete ispirata al minimalismo dell'arte moderna, proposta nelle varianti a 3 o 4 steli.

La sua peculiarità consiste nel poter orientare gli steli che la compongono, permettendovi di creare molteplici configurazioni in grado di arredare il vostro living in modo sempre differente / Tullia is the ceiling and wall lamp inspired by the minimalism of modern art, offered in 3 or 4 stem variants.

What makes the Tullia series special is that you are able to direct its stems, allowing you to create multiple configurations and illuminate your living room in an ever-changing way.





TECHNICAL INFORMATION

Plafoniere con montatura in alluminio satinato bianco. Diffusore in silicone bianco opale.

Sorgente luminosa led./

Ceiling lighting with satin white aluminium frame. Opal white silicone diffuser.

LED light source.

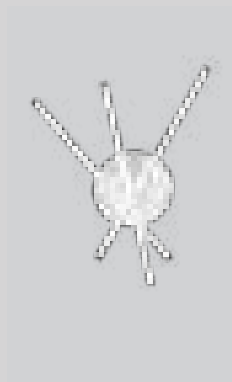
**TULLIA P/3 3000°K**

Socket: **3 moduli LED**
 Power: **max 30W**
 Input: **220/240V**
 Lumen: **1700Lm**
 CRI: **>80**
 Light temp.: **3000°K**
 Pack: **0,019 m³**

TULLIA P/3 4000°K

Socket: **3 moduli LED**
 Power: **max 30W**
 Input: **220/240V**
 Lumen: **1700Lm**
 CRI: **>80**
 Light temp.: **4000°K**
 Pack: **0,019 m³**

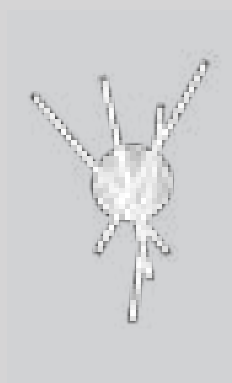
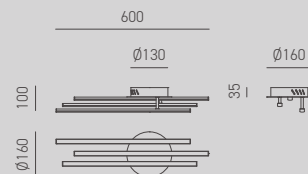
**TULLIA P/4 3000°K**

Socket: **4 moduli LED**
 Power: **max 40W**
 Input: **220/240V**
 Lumen: **2200Lm**
 CRI: **>80**
 Light temp.: **3000°K**
 Pack: **0,027 m³**

TULLIA P/4 4000°K

Socket: **4 moduli LED**
 Power: **max 40W**
 Input: **220/240V**
 Lumen: **2200Lm**
 CRI: **>80**
 Light temp.: **4000°K**
 Pack: **0,027 m³**

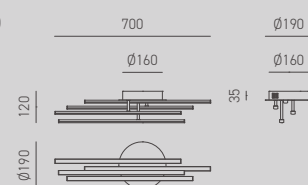

FINISHING



Bianco Satinato / Satin White





TOSCA

Proposta nelle versioni a uno, tre e quattro steli ricurvi, led in linea continua, uno schermo protettivo che garantisce comfort visivo senza precludere la luminosità dell'apparecchio.

Design singolare e fresco che ben si adatta a qualunque stile di arredo /

Tosca is available in versions with one, three and four curved stems, LEDs in a continuous line and a protective screen that guarantees visual comfort without hindering the brightness of the lighting fixture.

Its unique and fresh design is well suited to any furnishing style.



TECHNICAL INFORMATION

Plafoniere con montatura in alluminio satinato bianco. Diffusore in silicone bianco opale.

Sorgente luminosa led./

Ceiling lighting with satin white aluminium frame.

Opal white silicone diffuser.

LED light source.

**TOSCA P/1 3000°K**

Socket: **1 modulo LED**
 Power: **max 15W**
 Input: **220/240V**
 Lumen: **840Lm**
 CRI: **>80**
 Light temp.: **3000°K**
 Pack: **0,024 m³**

TOSCA P/1 4000°K

Socket: **1 modulo LED**
 Power: **max 15W**
 Input: **220/240V**
 Lumen: **840Lm**
 CRI: **>80**
 Light temp.: **4000°K**
 Pack: **0,024 m³**

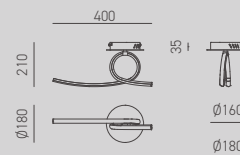
**TOSCA P/3 3000°K**

Socket: **3 moduli LED**
 Power: **max 45W**
 Input: **220/240V**
 Lumen: **2500Lm**
 CRI: **>80**
 Light temp.: **3000°K**
 Pack: **0,059 m³**

TOSCA P/3 4000°K

Socket: **3 moduli LED**
 Power: **max 45W**
 Input: **220/240V**
 Lumen: **2500Lm**
 CRI: **>80**
 Light temp.: **4000°K**
 Pack: **0,059 m³**

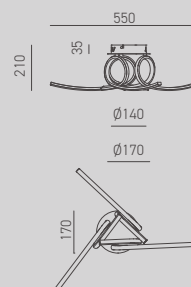
**TOSCA P/4 3000°K**

Socket: **4 moduli LED**
 Power: **max 60W**
 Input: **220/240V**
 Lumen: **3200Lm**
 CRI: **>80**
 Light temp.: **3000°K**
 Pack: **0,049 m³**

TOSCA P/4 4000°K

Socket: **4 moduli LED**
 Power: **max 60W**
 Input: **220/240V**
 Lumen: **3200Lm**
 CRI: **>80**
 Light temp.: **4000°K**
 Pack: **0,049 m³**

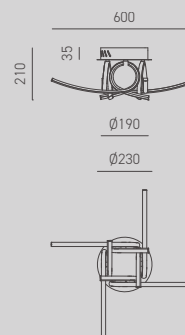

FINISHING



Bianco Satinato / Satin White



TESSA

Perfetta sintesi di semplicità e funzionalità, con le sue fattezze sinuose e minimali Tessa genera un'armonia unica, piacevole e rilassante. Progettata nelle due varianti a 3 e 5 steli, viene proposta esclusivamente nella finitura verniciata bianca che ne esalta esplicitamente il candore / With its sinuous and minimalist features, Tessa generates a unique, pleasant and relaxing harmony through the perfect synthesis of simplicity and functionality. The series is designed in two variants with 3 and 5 stems and is offered exclusively in a white painted finish which expressly enhances its brilliant pale quality.



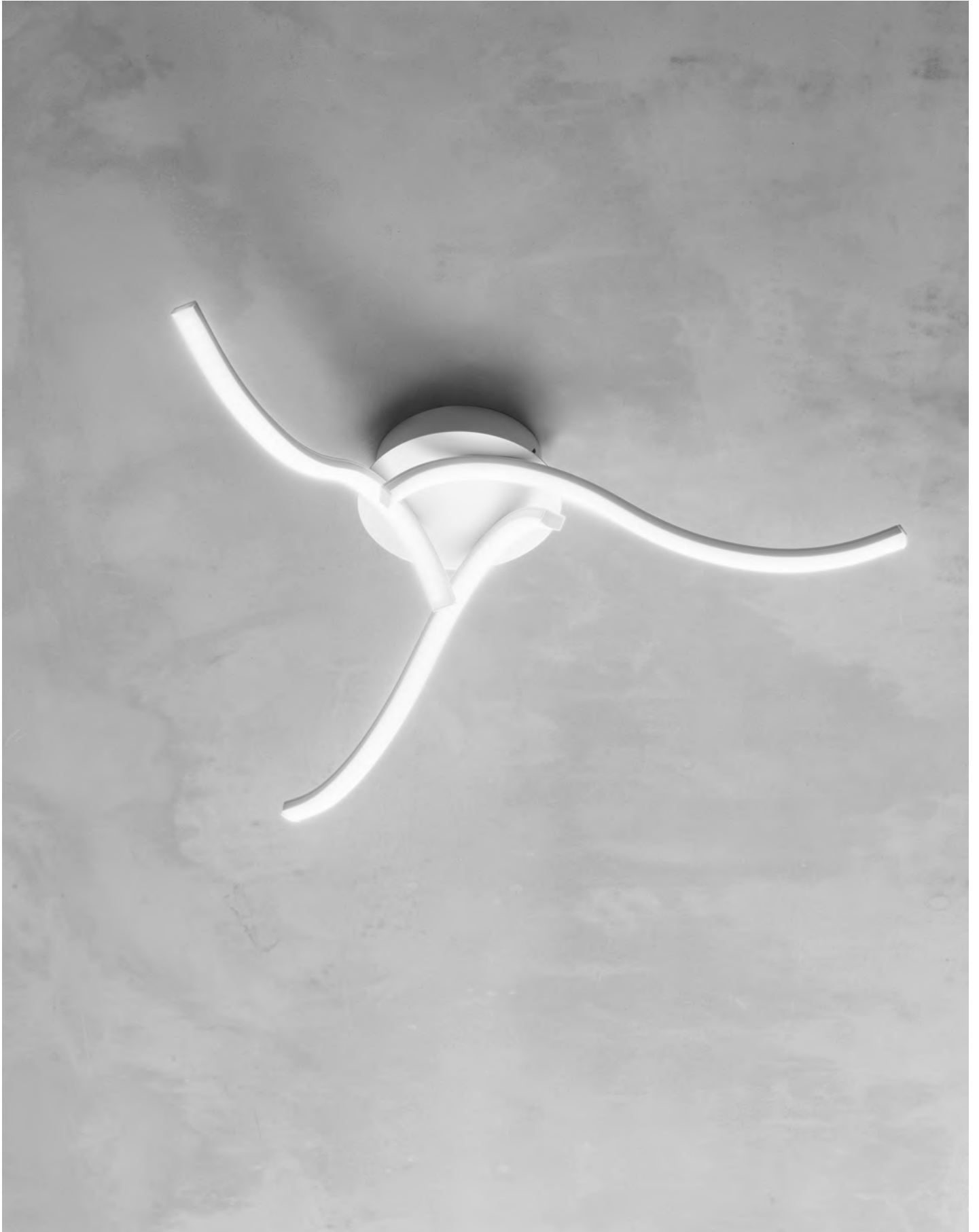

TECHNICAL INFORMATION

Plafoniere con montatura in alluminio satinato bianco. Diffusore in silicone bianco opale.

Sorgente luminosa led./

Ceiling lighting with satin white aluminium frame.

Opal white silicone diffuser.

LED light source.

**TESSA P/3 3000°K**

Socket: **3 moduli LED**
 Power: **max 23W**
 Input: **220/240V**
 Lumen: **1300Lm**
 CRI: **>80**
 Light temp.: **3000°K**
 Pack: **0,053 m³**

TESSA P/3 4000°K

Socket: **3 moduli LED**
 Power: **max 23W**
 Input: **220/240V**
 Lumen: **1300Lm**
 CRI: **>80**
 Light temp.: **4000°K**
 Pack: **0,053 m³**

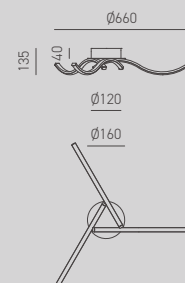
**TESSA P/5 3000°K**

Socket: **5 moduli LED**
 Power: **max 38W**
 Input: **220/240V**
 Lumen: **2300Lm**
 CRI: **>80**
 Light temp.: **3000°K**
 Pack: **0,074 m³**

TESSA P/5 4000°K

Socket: **5 moduli LED**
 Power: **max 38W**
 Input: **220/240V**
 Lumen: **2300Lm**
 CRI: **>80**
 Light temp.: **4000°K**
 Pack: **0,074 m³**

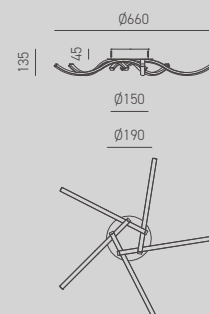

FINISHING



Bianco Satinato / Satin White

MELANIA

Dare forma alla forma. Un gioco di parole o una semplice sottolineatura? Due semplici circonferenze inscritte l'una nell'altra: Melania rappresenta un'intuizione stilistica in grado di arricchire di significato e stile l'ambiente che la accoglie / Giving shape to shape. A play on words or merely emphasising its meaning? Melania features two simple circumferences inscribed one inside the other, representing a stylistic intuition capable of enhancing any space with meaning and style.







TECHNICAL INFORMATION

Montatura in alluminio verniciato bianco.
 Diffusore in metacrilato satinato bianco.
 Sorgente luminosa led./
 White painted aluminium frame.
 Satin white methacrylate diffuser.
 LED light source.

**MELANIA P/P 3000°K**

Socket: **2 moduli LED**
 Power: **max 30W**
 Input: **220/240V**
 Lumen: **1300Lm**
 CRI: **>80**
 Light temp.: **3000°K**
 Pack: **0,012 m³**

MELANIA P/P 4000°K

Socket: **2 moduli LED**
 Power: **max 30W**
 Input: **220/240V**
 Lumen: **1600Lm**
 CRI: **>80**
 Light temp.: **4000°K**
 Pack: **0,012 m³**

**MELANIA P/M 3000°K**

Socket: **2 moduli LED**
 Power: **max 40W**
 Input: **220/240V**
 Lumen: **1700Lm**
 CRI: **>80**
 Light temp.: **3000°K**
 Pack: **0,020 m³**

MELANIA P/M 4000°K

Socket: **2 moduli LED**
 Power: **max 40W**
 Input: **220/240V**
 Lumen: **1820Lm**
 CRI: **>80**
 Light temp.: **4000°K**
 Pack: **0,020 m³**

**MELANIA P/G 3000°K**

Socket: **2 moduli LED**
 Power: **max 50W**
 Input: **220/240V**
 Lumen: **2100Lm**
 CRI: **>80**
 Light temp.: **3000°K**
 Pack: **0,029 m³**

MELANIA P/G 4000°K

Socket: **2 moduli LED**
 Power: **max 50W**
 Input: **220/240V**
 Lumen: **2260Lm**
 CRI: **>80**
 Light temp.: **4000°K**
 Pack: **0,029 m³**



FINISHING

 Bianco / White

MANILA

Profilo morbido, aria informale.
Nell'essentialismo puro del colore
bianco, Manila oltre che fonte di
luce diventa vero e proprio oggetto
di design, sviluppando divertenti
composizioni possibili grazie alle
tre dimensioni proposte /
Soft profile, informal air. In the
pure essentialism of white, Manila
is more than just a light source;
it becomes a veritable design
object. The three dimensions
available allow you to develop fun
compositions.







TECHNICAL INFORMATION

Montatura in alluminio verniciato bianco, diffusore in metacrilato e alluminio con finiture in bianco.

Sorgente luminosa led dimmerabile (push) /

White painted aluminium fitting, diffuser methacrylate and aluminium finished in white, dove grey, black, gold leaf or silver leaf. Dimmable led light source (push).

**MANILA P/P**

Socket: **1 modulo LED**
 Power: **max 30W**
 Input: **220/240V**
 Lumen: **2760Lm**
 CRI: **>80**
 Light temp.: **3000°K**
 Pack: **0,027 m³**

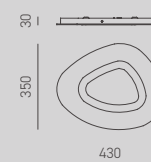
**MANILA P/M**

Socket: **1 modulo LED**
 Power: **max 35W**
 Input: **220/240V**
 Lumen: **3220Lm**
 CRI: **>80**
 Light temp.: **3000°K**
 Pack: **0,050 m³**

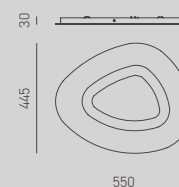
**MANILA P/G**

Socket: **1 modulo LED**
 Power: **max 45W**
 Input: **220/240V**
 Lumen: **3750Lm**
 CRI: **>80**
 Light temp.: **3000°K**
 Pack: **0,060 m³**

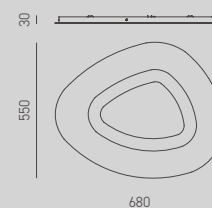

FINISHING

Bianco / White



ARIA

Pura leggerezza in queste due vele che sembrano sostenute da una calda brezza generata dalla luce. Progettata nelle varianti bianco totale e bicolore bianco/tortora per suscitare emozione, riflessi, ombreggiature, bagliori studiati a regola d'arte /

These two sails radiate pure lightness, seemingly supported by a warm breeze generated by the light. The total white and two-tone white/dove grey variants were designed to create delightful reflections, shadows and rays of light conceived to perfection.









TECHNICAL INFORMATION

Montatura in alluminio bianco.
 Diffusore in metacrilato. Dissipatore
 in alluminio con finiture bianco e tortora.
 Sorgente luminosa cob led
 dimmerabile (push) /
 White painted aluminium fitting.
 Methacrylate diffuser.
 Aluminium heatsink with white,
 dove grey. Dimmable cob led light
 source (push).

**ARIA A**

Socket: **2 moduli LED**
 Power: **20W**
 Input: **220/240V**
 Lumen: **1800Lm**
 CRI: **>80**
 Light temp.: **3000°K**
 Pack: **0,017 m³**

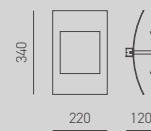
**ARIA P/P**

Socket: **2 moduli LED**
 Power: **20W**
 Input: **220/240V**
 Lumen: **1800Lm**
 CRI: **>80**
 Light temp.: **3000°K**
 Pack: **0,025 m³**

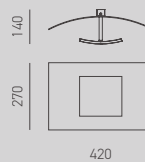
**ARIA P/M**

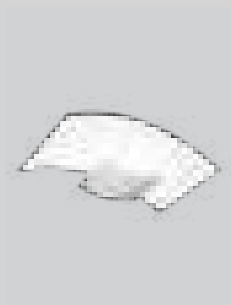
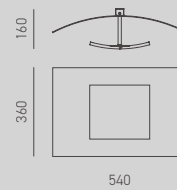

Socket: **2 moduli LED**
 Power: **40W**
 Input: **220/240V**
 Lumen: **3600Lm**
 CRI: **>80**
 Light temp.: **3000°K**
 Pack: **0,046 m³**

**ARIA P/G**

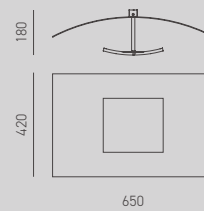
Socket: **2 moduli LED**
 Power: **40W**
 Input: **220/240V**
 Lumen: **3600Lm**
 CRI: **>80**
 Light temp.: **3000°K**
 Pack: **0,070 m³**



FINISHING

-  Bianco / White
-  Tortora / Dove grey

GRACE

Il benessere visivo è assicurato dal diffusore in metacrilato bianco bisatinato, incorniciato da linee rette che si intersicano e conferiscono un'elegante ed attuale essenzialità al design. La serie si arricchisce con le nuove finiture in oro e argento oltre che alle consuete verniciature del bianco, nero e tortora /

Visual well-being is ensured by the frosted, white methacrylate diffuser, framed by straight lines that intersect and lend an elegant and contemporary simplicity to the design. The series is enriched with new finishes in gold and silver as well as the usual white, black and dove-grey paints.









TECHNICAL INFORMATION

Montatura in alluminio bianco.

Diffusore in metacrilato bisatinato e alluminio con finiture acciaio, bianco, nero, oro e tortora.

Sorgente luminosa led dimmerabile (push) /

White aluminium frame.

Diffuser in double-coated methacrylate and aluminium with steel, white, black, gold and dove grey finishes.

Dimmable led light source (push)

**GRACE P/P**

Socket: **1 modulo LED**
 Power: **max 25W**
 Input: **220/240V**
 Lumen: **2500Lm**
 CRI: **>80**
 Light temp.: **3000°K**
 Pack: **0,036 m³**

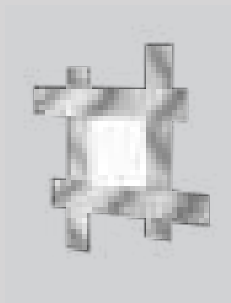
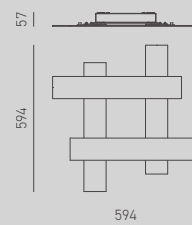
**GRACE P/M**

Socket: **1 modulo LED**
 Power: **max 39W**
 Input: **220/240V**
 Lumen: **3900Lm**
 CRI: **>80**
 Light temp.: **3000°K**
 Pack: **0,041 m³**

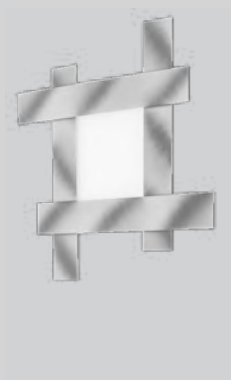
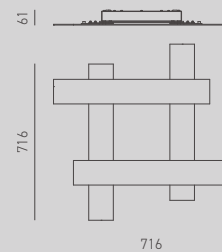
**GRACE P/G**

Socket: **1 modulo LED**
 Power: **max 56W**
 Input: **220/240V**
 Lumen: **5600Lm**
 CRI: **>80**
 Light temp.: **3000°K**
 Pack: **0,060 m³**

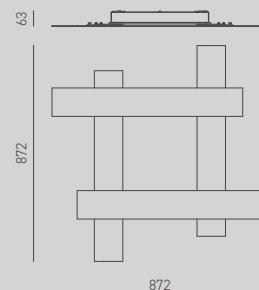

FINISHING

-  Acciaio / Steel
-  Bianco / White
-  Nero / Black
-  Oro / Gold
-  Tortora / Dove grey

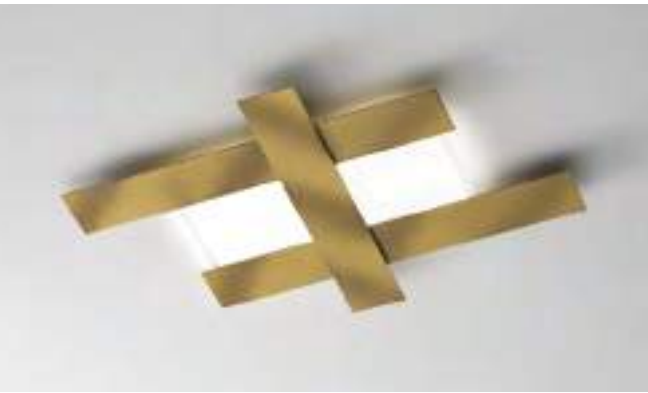

DOHA

Design rigido, linearità convenzionali ma al contempo indefinite per questa collezione che rievoca il cubismo nella sua ricerca della semplificazione. Ad arricchire il tutto nuove colorazioni /

Doha features strict design and conventional linearity, which is simultaneously undefined. This collection evokes cubism in its search for simplification. Doha is enriched with new colours.



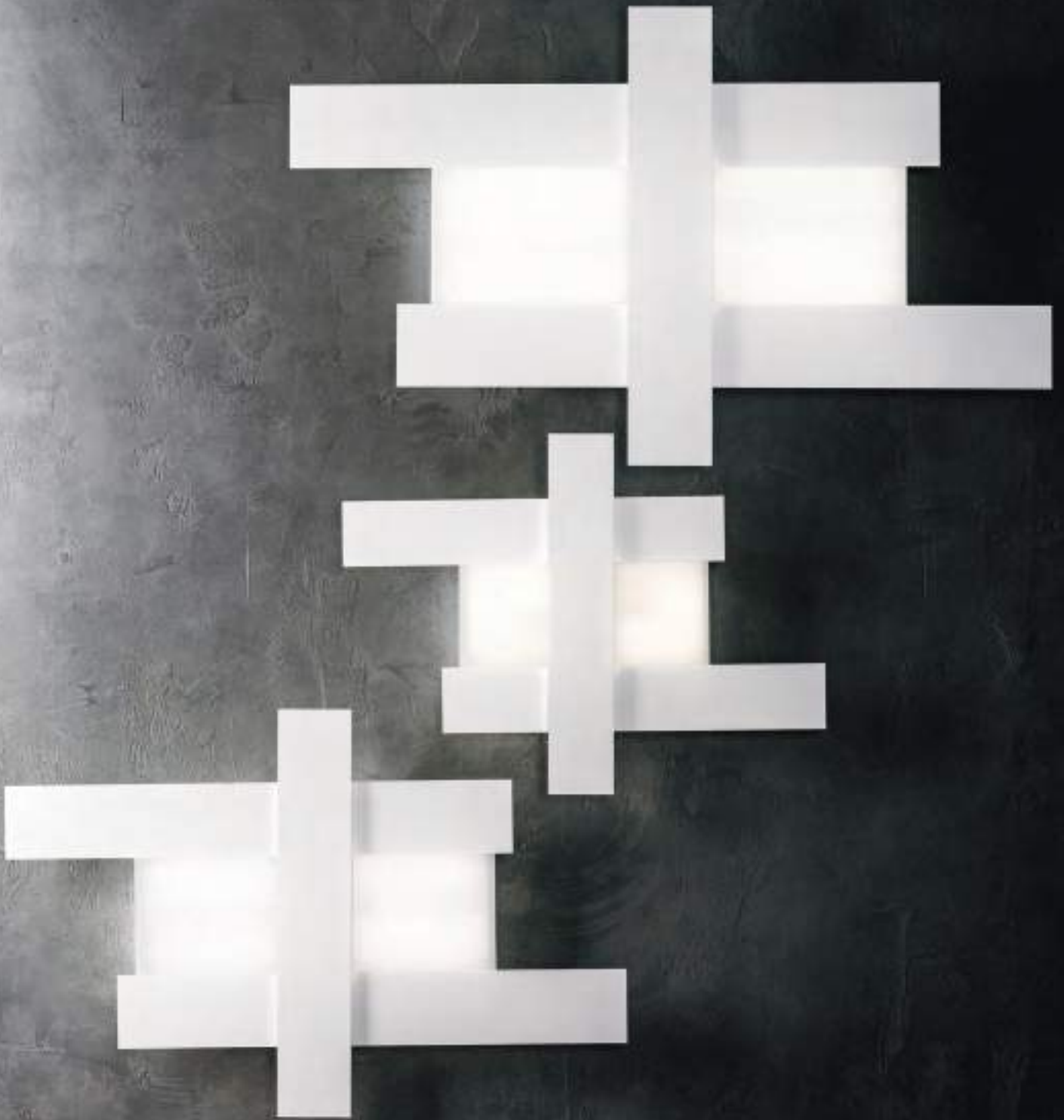



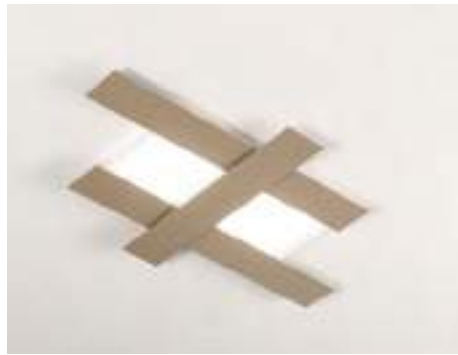













TECHNICAL INFORMATION

Montatura in alluminio bianco.
 Diffusore in metacrilato bisatinato
 e alluminio con finiture acciaio,
 bianco, nero, oro e tortora.
 Sorgente luminosa led /
 White aluminium frame.
 Diffuser in double-coated methacrylate
 and aluminium with steel, white,
 black, gold and dove grey finishes.
 Led light source.

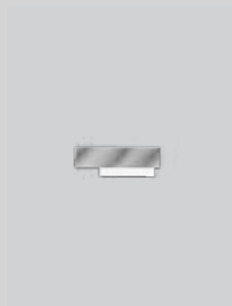
**DOHA A/P**

Socket: **1 modulo LED**
 Power: **max 15W**
 Input: **220/240V**
 Lumen: **1270Lm**
 CRI: **>80**
 Light temp.: **3000°K**
 Pack: **0,013 m³**

**DOHA A/G**

Socket: **1 modulo LED**
 Power: **max 25W**
 Input: **220/240V**
 Lumen: **2110Lm**
 CRI: **>80**
 Light temp.: **3000°K**
 Pack: **0,027 m³**

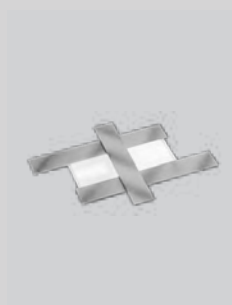
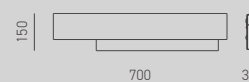
**DOHA P/P**

Socket: **2 moduli LED**
 Power: **max 30W**
 Input: **220/240V**
 Lumen: **2620Lm**
 CRI: **>80**
 Light temp.: **3000°K**
 Pack: **0,029 m³**

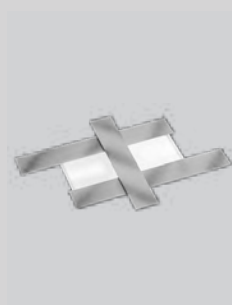
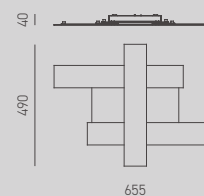
**DOHA P/M**

Socket: **2 moduli LED**
 Power: **max 40W**
 Input: **220/240V**
 Lumen: **3750Lm**
 CRI: **>80**
 Light temp.: **3000°K**
 Pack: **0,046 m³**

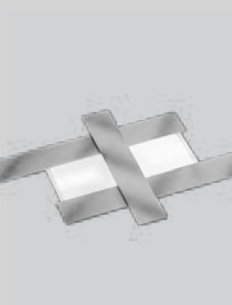
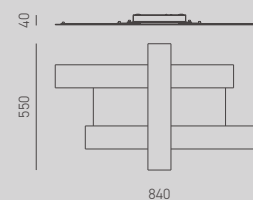
**DOHA P/G**

Socket: **2 moduli LED**
 Power: **max 50W**
 Input: **220/240V**
 Lumen: **4470Lm**
 CRI: **>80**
 Light temp.: **3000°K**
 Pack: **0,080 m³**

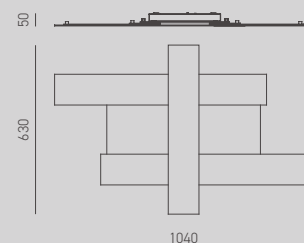

FINISHING

-  Acciaio / Steel
-  Bianco / White
-  Nero / Black
-  Oro / Gold
-  Tortora / Dove grey



SOLE

La sua figura piatta, quadrangolare, ingentilita da sagaci arrotondamenti, la rendono adatta a valorizzare ogni ambiente.

La versione a plafoniera è disponibile in più dimensioni, con più punti luci, mentre la stupenda sospensione permette un'illuminazione a luce diretta ed indiretta. Concisa e sofisticata allo stesso tempo / The flat, quadrangular shape is softened by a discerning rounding of the edges, making it suitable to enhance any space.

The ceiling lamp version is available in various sizes, featuring multiple light points, while the beautiful pendant lamp allows you to create direct and indirect lighting.

Succinct and sophisticated at the same time.

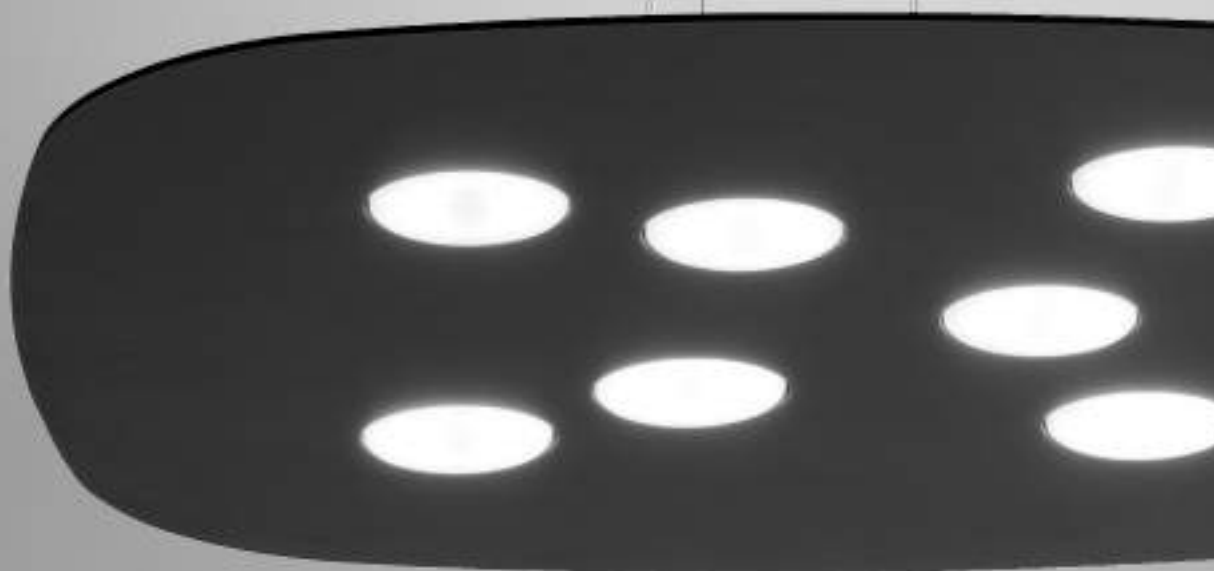







TECHNICAL INFORMATION

Montatura in metallo bianco.
 Diffusore in alluminio
 con finiture acciaio, bianco, nero e oro.
 Sospensione con luce in biemissione.
 Rosone bianco per finiture bianco e nero.
 Rosone in tinta per finiture acciaio e oro.
 Lampadine non incluse /
 White metal frame.

Aluminium diffuser with steel, white, black
 and gold finishes. Suspension with two
 light sources.

White canopy for white and black finishes.
 Matching canopy for steel and
 gold finishes.

Bulbs not included.

**SOLE P/P**

Socket: **3xGx53**
 Power: **max 3x8W**
 Input: **220/240V**
 Pack: **0,029 m³**

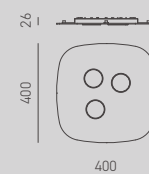
**SOLE P/M**

Socket: **5xGx53**
 Power: **max 5x8W**
 Input: **220/240V**
 Pack: **0,047 m³**

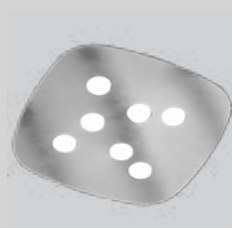
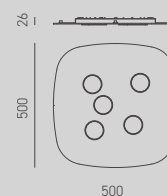
**SOLE P/G**

Socket: **7xGx53**
 Power: **max 7x8W**
 Input: **220/240V**
 Pack: **0,070 m³**

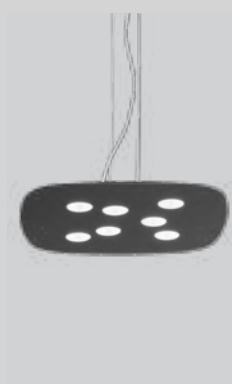
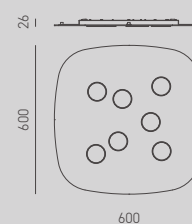
**SOLE S**

Socket: **1xGx53 up**
7xGx53 down
 Power: **max 1x8W up**
max 7x8W down
 Input: **220/240V**
 Pack: **0,070 m³**

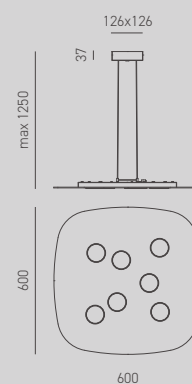

FINISHING

-  Acciaio / Steel
-  Bianco / White
-  Nero / Black
-  Oro / Gold

Nel riquadro sono
 raffigurati il nuovo sistema di
 aggancio delle plafoniere
 ed il sistema di biemissione
 delle sospensioni /
 In detail are shown the
 hooking system o
 the ceiling lights and
 the bi-emission system
 of the suspensions.

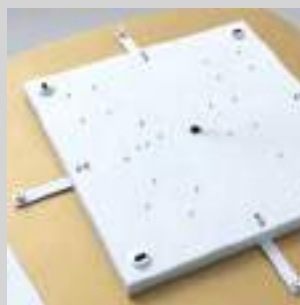



OLIMPIA

Olimpia è la naturale evoluzione della collezione Sole, quasi una sorta di estensione, con forme più longilinee e slanciate ideali per impreziosire le superfici meno generose lasciando comunque un segno distintivo. Progettata esclusivamente come plafoniera viene proposta in tre interessanti formati dimensionali /

Olimpia is the natural evolution of the Sole collection; it could almost be considered a sort of extension. The slimmer and leaner shapes are ideal for embellishing less spacious surfaces while still leaving a distinctive mark. Designed exclusively as a ceiling lamp, Olimpia is available in three attractive dimensional formats.





TECHNICAL INFORMATION

Montatura in metallo bianco.
 Diffusore in alluminio con finiture acciaio,
 bianco, nero e oro.
 Lampadine non incluse./
 White metal frame. Aluminium diffuser
 with steel, white, black and gold finishes.
 Bulbs not included.

**OLIMPIA P/P**

Socket: **3xGx53**
 Power: **max 3x8W**
 Input: **220/240V**
 Pack: **0,026 m³**

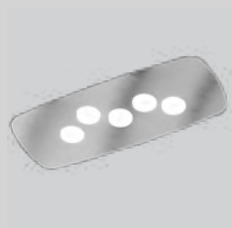
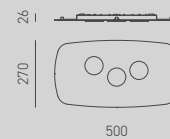
**OLIMPIA P/M**

Socket: **5xGx53**
 Power: **max 5x8W**
 Input: **220/240V**
 Pack: **0,041 m³**

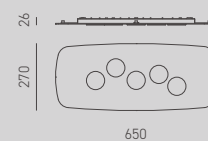
**OLIMPIA P/G**

Socket: **7xGx53**
 Power: **max 7x8W**
 Input: **220/240V**
 Pack: **0,035 m³**

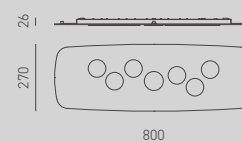

FINISHING

-  Acciaio / Steel
-  Bianco / White
-  Nero / Black
-  Oro / Gold

Nel riquadro è
 raffigurato il nuovo sistema di
 aggancio delle plafoniere /
 In detail is show
 the new hooking system
 for the ceiling lights.

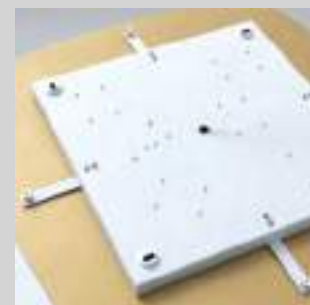





IRENE

Semplice nel concept ma ricercata nei dettagli, la caratterizza una linea asimmetrica guarnita da un inserto cromatico perfetto per esaltare il dettaglio del punto luce. Declinata nei colori bianco, nero, oro nelle varianti a sospensione e a plafoniera, Irene porta brio nella tua casa con la sua verve innata / A simple concept that features sophisticated details; Irene is characterised by an asymmetrical line adorned with a colour insert that perfectly enhances the detail of the light point. Available in white, black, gold in the pendant and ceiling lamp variants, Irene brings liveliness to your home with its innate verve.







TECHNICAL INFORMATION

Montatura in metallo bianco.
 Diffusore in alluminio
 con finiture bianco/acciaio,
 nero/oro e oro/nero.
 Sospensione con luce in biemissione.
 Rosone bianco per finitura bianco/acciaio.
 Rosone nero per finitura nero/oro.
 Rosone oro per finitura oro/nero.
 Lampadine non incluse /
 White metal frame.

Aluminium diffuser with white/steel,
 black/gold and gold/black finishes.
 Suspension with two light sources.
 White canopy for white/steel finishes.
 Black canopy for black/gold finishes.
 Gold canopy for gold/black finishes.
 Bulbs not included.

**IRENE P/P**

Socket: **3xGx53**
 Power: **max 3x8W**
 Input: **220/240V**
 Pack: **0,029 m³**

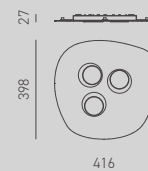
**IRENE P/M**

Socket: **5xGx53**
 Power: **max 5x8W**
 Input: **220/240V**
 Pack: **0,047 m³**

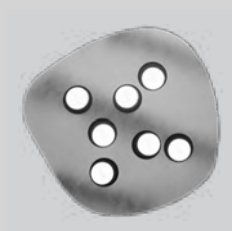
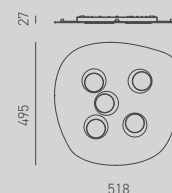
**IRENE P/G**

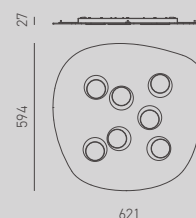

Socket: **7xGx53**
 Power: **max 7x8W**
 Input: **220/240V**
 Pack: **0,070 m³**

**IRENE S**

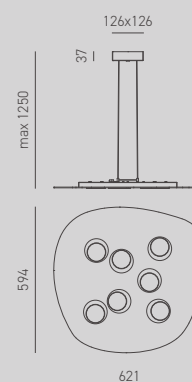
Socket: **1xGx53 up**
7xGx53 down
 Power: **max 1x8W up**
max 7x8W down
 Input: **220/240V**
 Pack: **0,070 m³**



FINISHING

-  Bianco-Acciaio / White-Steel
-  Nero-Oro / Black-Gold
-  Oro-Nero / Gold-Black

Nel riquadro sono raffigurati il nuovo sistema di aggancio delle plafoniere ed il sistema di biemissione delle sospensioni / In detail are shown the hooking system of the ceiling lights and the bi-emission system of the suspensions.

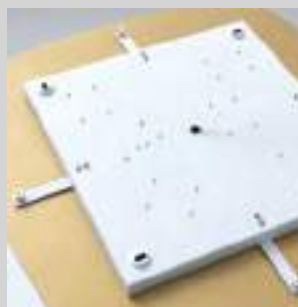





GISELLE

Rappresenta il minimalismo perfetto. Forma quadrata sgrossata da angoli arrotondati, tasselli luminosi disposti apparentemente in modo casuale sulla superficie creano elementi aggraziati, materia e luce si fondono in un'unica sostanza. Giselle viene proposta come sospensione, con illuminazione diretta/indiretta, e come plafoniera da sette, cinque o tre luci ripartite ciascuna in tre superfici dimensionalmente diverse /

Representing perfect minimalism. Rounded corners roughen Giselle's square shape; the surface features luminous tiles seemingly arranged at random to create graceful elements where matter and light merge into a single substance. Giselle is available as a pendant lamp, with direct/indirect lighting, and as a ceiling lamp with seven, five or three lights each divided into three surfaces with varying dimensions.



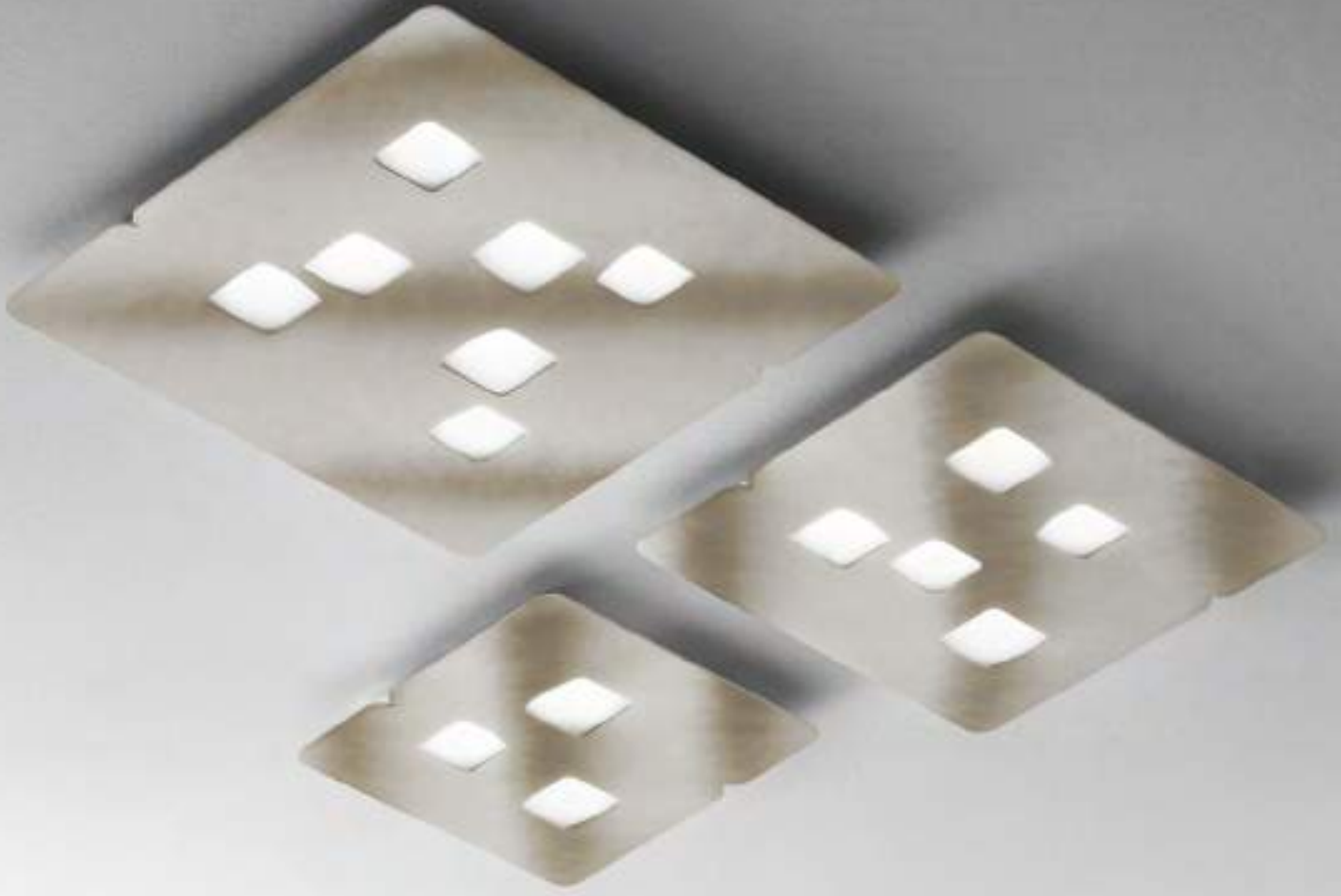

TECHNICAL INFORMATION

Montatura in metallo bianco.
 Diffusore in metacrilato e alluminio
 con finiture acciaio, bianco, oro e tortora.
 Sospensione con luce in biemissione.
 Rosone bianco per finiture bianco e
 tortora. Rosone in tinta per finiture
 acciaio e oro.

Lampadine non incluse/
 White metal frame.

Diffuser in methacrylate and aluminium
 with steel, white, gold and dove grey
 finishes.

Suspension with two light sources.
 White canopy for white and
 dove grey finishes. Matching canopy
 for steel and gold finishes.
 Bulbs not included.

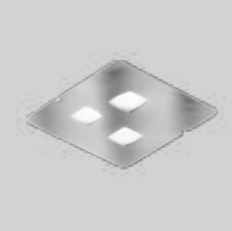
**GISELLE P/P**

Socket: **3xGx53**
 Power: **max 3x8W**
 Input: **220/240V**
 Pack: **0,024 m³**

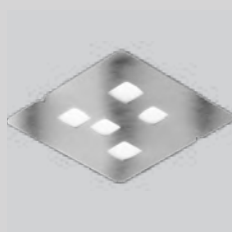
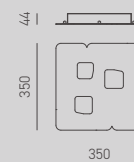
**GISELLE P/M**

Socket: **5xGx53**
 Power: **max 5x8W**
 Input: **220/240V**
 Pack: **0,040 m³**

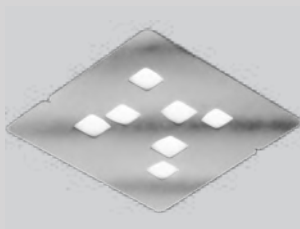
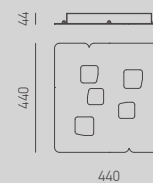
**GISELLE P/G**

Socket: **7xGx53**
 Power: **max 7x8W**
 Input: **220/240V**
 Pack: **0,054 m³**

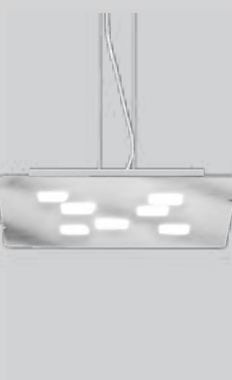
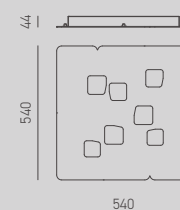
**GISELLE S**

Socket: **3xGx53 up**
7xGx53 down
 Power: **max 3x8W up**
max 8W down
 Input: **220/240V**
 Pack: **0,054 m³**

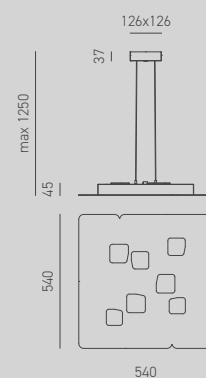

FINISHING

-  Acciaio / Steel
-  Bianco / White
-  Oro / Gold
-  Tortora / Dove grey

Nel riquadro sono
 raffigurati il nuovo sistema di
 aggancio delle plafoniere
 ed il sistema di biemissione
 delle sospensioni /
 In detail are shown the
 hooking system o
 the ceiling lights and
 the bi-emission system
 of the suspensions.

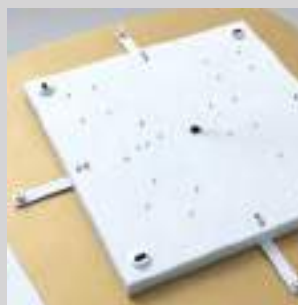

BILBAO

Morbidi quadrati si alternano danzando sulla superficie delle lampade di questa collezione dall'animo attuale, ideale per portare un tocco di design irriverente in qualsiasi ambiente.

Al diffusore in metacrilato e alluminio, si aggiungono nuove finiture oro e argento ai classici bianco e tortora /

Soft squares alternate, dancing over the surface of the lamps in this collection which is characterised by a modern soul.

Bilbao is ideal for bringing a touch of irreverent design to any space. New gold and silver finishes are added to the classic white and dove grey versions of the methacrylate and aluminium diffuser.





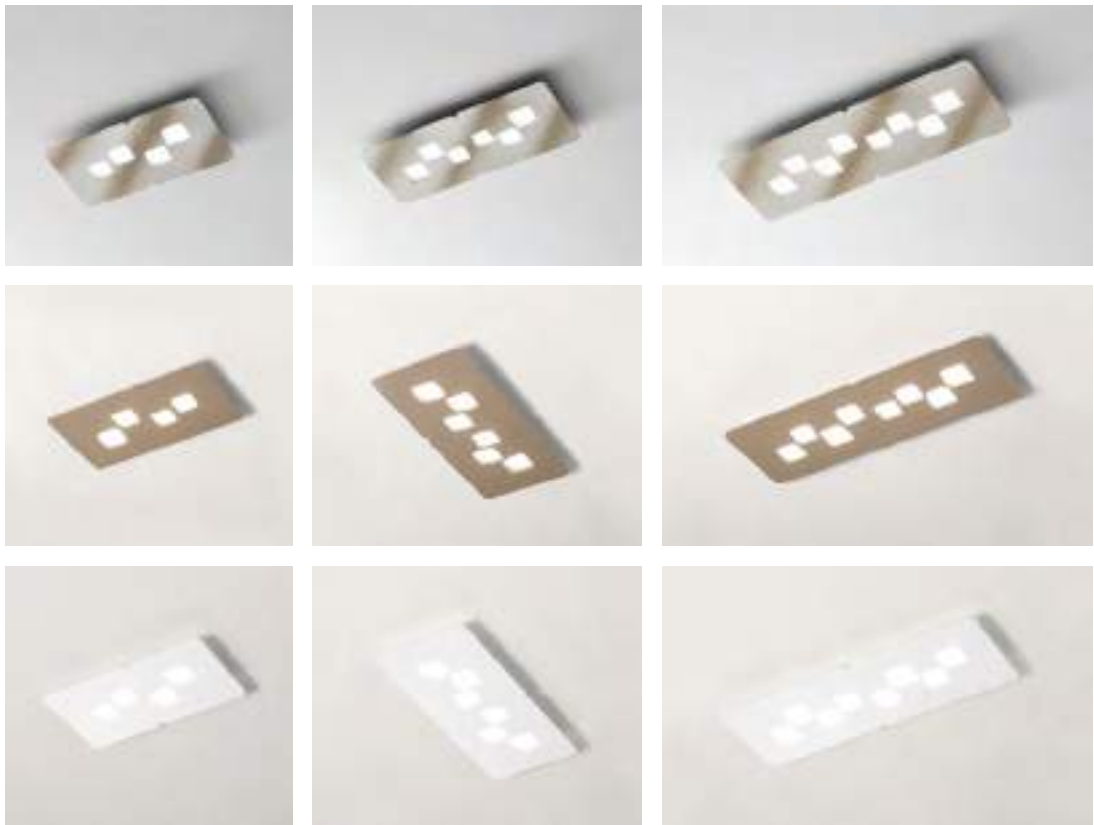





TECHNICAL INFORMATION

Montatura in metallo bianco.
 Diffusore in metacrilato
 e alluminio con finiture acciaio, bianco,
 oro e tortora. Lampadine non incluse /
 White painted metal fitting.
 Methacrylate and aluminium diffuser
 with steel, white, gold and
 dove grey finishes. Bulbs not
 included.

**BILBAO P/P**

Socket: **4xGx53**
 Power: **max 4x8W**
 Input: **220/240V**
 Pack: **0,025 m³**

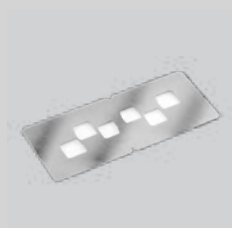
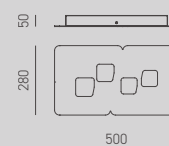
**BILBAO P/M**

Socket: **6xGx53**
 Power: **max 6x8W**
 Input: **220/240V**
 Pack: **0,041 m³**

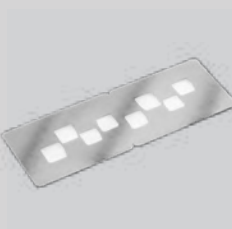
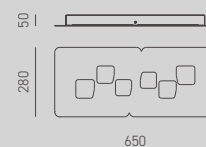
**BILBAO P/G**

Socket: **8xGx53**
 Power: **max 8x8W**
 Input: **220/240V**
 Pack: **0,035 m³**

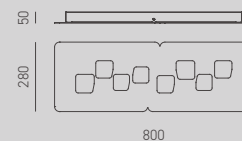

FINISHING

-  Acciaio / Steel
-  Bianco / White
-  Oro / Gold
-  Tortora / Dove grey





LUNA

Dolcezza ricercata nelle sue forme circolari concentriche e nelle superfici levigate. Luna riempie ogni stanza col suo stile essenziale, da sola o giocando a comporre disposizioni divertenti con le sue tre varianti di dimensione nella versione da soffitto /

Luna expresses sophisticated sweetness in its concentric circular shapes and smooth surfaces. Luna fills every room with its minimalist style, alone or grouped to compose fun arrangements with its three-dimensional variations in the ceiling lamp version.







TECHNICAL INFORMATION

Montatura in metallo bianco.
 Diffusore in metacrilato
 e alluminio con finiture bianco e tortora.
 Sospensione con luce in biemissione.
 Lampadine non incluse /
 White painted metal fitting. Methacrylate
 and aluminium diffuser with white and
 dove grey finish.
 Suspension with light in biemission.
 Bulbs not included.

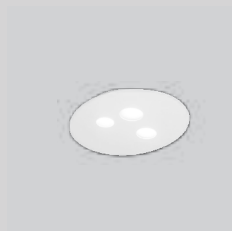
**LUNA P/P**

Socket: **3xGx53**
 Power: **max 3x8W**
 Input: **220/240V**
 Pack: **0,037 m³**

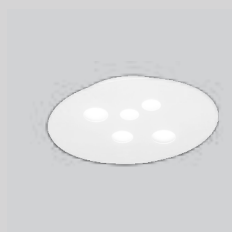
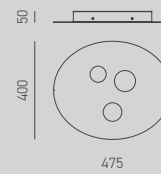
**LUNA P/M**

Socket: **5xGx53**
 Power: **max 5x8W**
 Input: **220/240V**
 Pack: **0,050 m³**

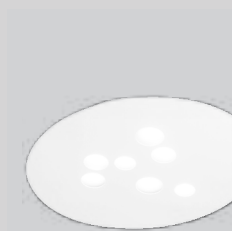
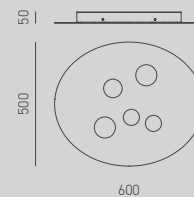
**LUNA P/G**

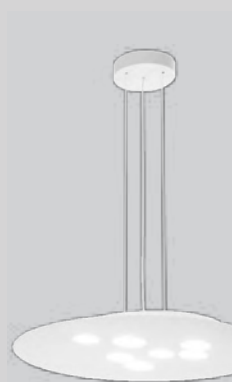
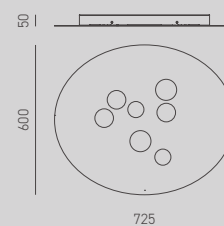

Socket: **7xGx53**
 Power: **max 7x8W**
 Input: **220/240V**
 Pack: **0,070 m³**

**LUNA S**

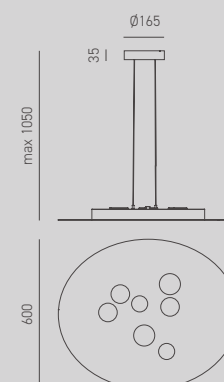
Socket: **3xGx53 up**
7xGx53 down
 Power: **max 3x8W up**
max 7x8W down
 Input: **220/240V**
 Pack: **0,070 m³**



FINISHING

-  Bianco / White
-  Tortora / Dove grey

Nel dettaglio
 è raffigurato il sistema
 di biemissione
 delle sospensioni /
 In detail is shown
 the bi-emission system
 of the suspensions.

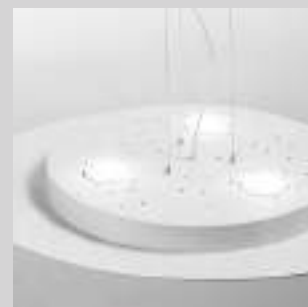

ISOTTA

Pulizia e funzionalità garantite dalla doppia emissione nella versione a sospensione, mentre la soluzione a soffitto caratterizza gli spazi per la sua adattabilità. Una collezione poliedrica, dal gusto deciso e da una grande anima / Isotta's suspended lamp version guarantees cleanliness and functionality with its double emission, while the adaptability of the ceiling solution characterises any space. Isotta is a multifaceted collection, with a distinctive taste and a great soul.









TECHNICAL INFORMATION

Montatura in metallo bianco.
 Diffusore in metacrilato
 e alluminio con finiture bianco e tortora.
 Sospensione con luce in biemissione.
 Lampadine non incluse /
 White painted metal fitting. Methacrylate
 and aluminium diffuser with white and
 dove grey finish.
 Suspension with light in biemission.
 Bulbs not included.

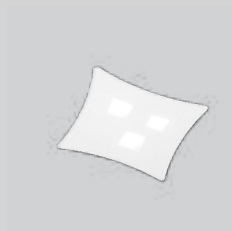
**ISOTTA P/P**

Socket: **3xGx53**
 Power: **max 3x8W**
 Input: **220/240V**
 Pack: **0,033 m³**

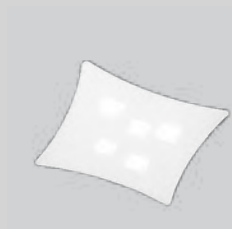
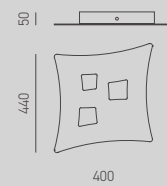
**ISOTTA P/M**

Socket: **5xGx53**
 Power: **max 5x8W**
 Input: **220/240V**
 Pack: **0,050 m³**

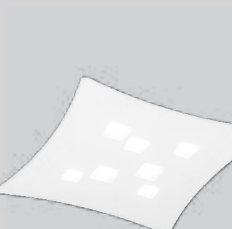
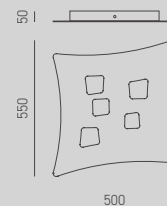
**ISOTTAP/G**

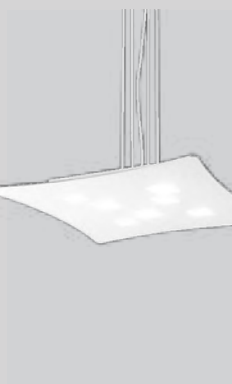
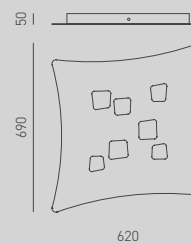

Socket: **7xGx53**
 Power: **max 7x8W**
 Input: **220/240V**
 Pack: **0,070 m³**

**ISOTTA S**

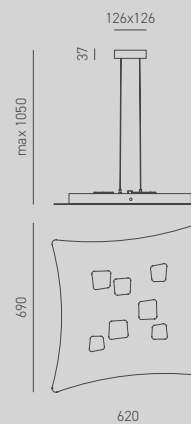
Socket: **3xGx53 up**
7xGx53 down
 Power: **max 3x8W up**
max 7x8W down
 Input: **220/240V**
 Pack: **0,070 m³**



FINISHING

-  Bianco / White
-  Tortora / Dove grey

Nel dettaglio
 è raffigurato il sistema
 di biemissione
 delle sospensioni /
 In detail is shown
 the bi-emission system
 of the suspensions.



ZAIRA

Presenza raffinata e delicata luce diffusa caratterizzano la collezione composta da piantana e lampada da tavolo, tracciata da una lineare struttura a treppiede rifinita da un fine diffusore in tessuto. Una montatura sofisticata che ben si abbina ad ambienti classici e contemporanei / The sophisticated presence and delicate diffused light characterise Zaira. The collection consists of a floor lamp and table lamp featuring a linear tripod structure that is refined with a fine fabric diffuser. The sophisticated frame is well suited to classic and contemporary settings.







TECHNICAL INFORMATION

Piantana e lume con montatura in metallo con finiture bianco satinato o nero satinato.

Paralume in tessuto bianco.

Lampadine non incluse./

Floor lamp and lamp with metal frame with satin white or satin black finishes.

Lampshade in white fabric.

Bulbs not included.

**ZAIRA L**

Socket: **1xE27**
 Power: **max 60W**
 Input: **220/240V**
 Pack: **0,048 m³**

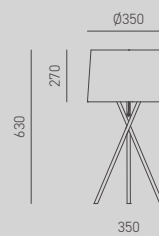
**ZAIRA PT**

Socket: **1xE27**
 Power: **max 60W**
 Input: **220/240 Volt**
 Pack: **0,113 m³**

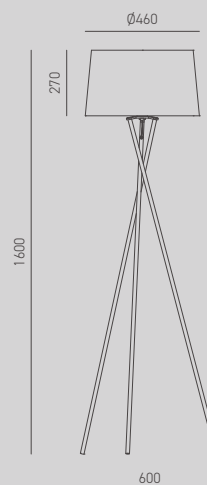

FINISHING

○ Bianco Satinato / Satin White

● Nero Satinato / Satin Black

TILDE

Tre staffe convergono in un singolo stelo centrale colorato, bianco o nero, dove una moderna asta telescopica cromata permette di variare e regolare l'altezza del paralume.

L'accensione a catenella è il tocco glamour di questa lampada da terra, che svela la sua anima classica reinterpretata secondo i moderni canoni del minimalismo /

Three brackets converge in a single central stem, available in black or white versions, where a modern chromed telescopic rod allows you to vary and adjust the height of the lampshade. The chainlink switch adds a glamorous touch to this floor lamp, which reveals a classic soul that is reinterpreted according to the modern canons of minimalism.





TECHNICAL INFORMATION



Piantana in metallo con finiture
bianco satinato e cromo o nero satinato
e cromo. Altezza del fusto regolabile.
Paralume in tessuto bianco.
Lampadine non incluse./
Metal floor lamp with satin white
and chrome or satin black and chrome
finishes. Height-adjustable stem.
Lampshade in white fabric.
Bulbs not included.

**TILDE PT**

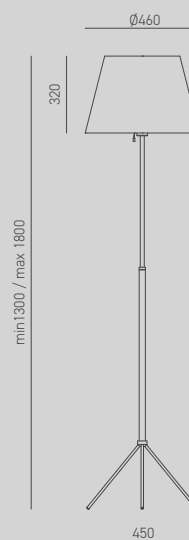
Socket: **1xE27**
Power: **max 60W**
Input: **220/240 Volt**
Pack: **0,100 m³**



FINISHING

-  Bianco satinato / Cromo
Satin white / Chrome
-  Nero satinato / Cromo
Black satin / Chrome



VANDA

Sobria e armoniosa, proposta come piantana, lume e applique, si distingue per la sua montatura essenziale. Le piccole dimensioni del paralume studiato per le versioni da parete e appoggio sono ideali per arredare la zona notte /

Restrained and harmonious, Vanda is available in a floor lamp, table lamp and wall lamp versions. The series stands out for its minimalist frame that allows the product.

The wall and table lamp versions are ideal for illuminating a bedroom thanks to the small dimensions of the lampshade.



TECHNICAL INFORMATION

Piantana, lume ed applique
con montatura in metallo
con finitura cromo.

Paralume in tessuto bianco.

Lampadine non incluse./

Floor lamp, lamp and wall lamp with
metal frame

with chrome finish.

Lampshade in white fabric.

Bulbs not included.

**VANDA A**

Socket: **1xE14**
Power: **max 40W**
Input: **220/240V**
Pack: **0,016 m³**

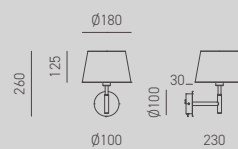
**VANDA L**

Socket: **1xE27**
Power: **max 18W**
Input: **220/240V**
Pack: **0,023 m³**

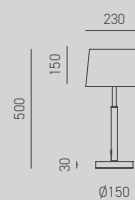
**VANDA PT**

Socket: **1xE27**
Power: **max 60W**
Input: **220/240 Volt**
Pack: **0,097 m³**

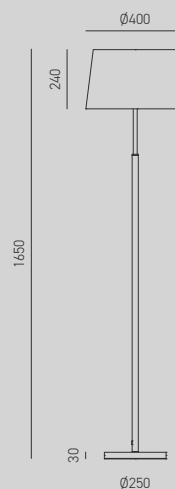

FINISHING



Cromo / Chrome



AIDA

La particolare versione da soffitto ad arco con asta telescopica, permette il decentramento del punto di alimentazione rispetto alla superficie da illuminare, dettando un'interpretazione moderna un classico senza eguali. A dare completezza a questa singolare linea sono il paralume bianco o nero, disponibile in due diametri, e la variante a sospensione con cavo d'acciaio / The unique arched ceiling lamp with telescopic rod allows the lamp to be decentralised from the power source with respect to the surface to be illuminated, dictating an unrivalled modern interpretation of a classic. The white or black lampshade, available in two diameters, and the pendant lamp variant with steel cable provide the finishing touches to this unique series.





TECHNICAL INFORMATION

Montatura estensibile in metallo con finitura cromo.
 Paralume in tessuto bianco o nero.
 Lampadine non incluse./
 Ceiling lamps with extendable metal frame with chrome finish.
 Lampshade in white or black fabric.
 Bulbs not included.

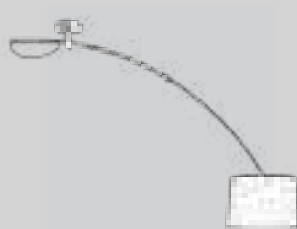
**AIDA P/P**

Socket: **1xE27**
 Power: **max 60W**
 Input: **220/240V**
 Pack: **0,088 m³**

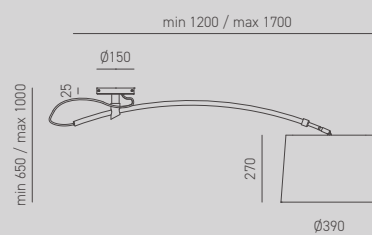
**AIDA P/G**

Socket: **1xE27**
 Power: **max 60W**
 Input: **220/240V**
 Pack: **0,128 m³**

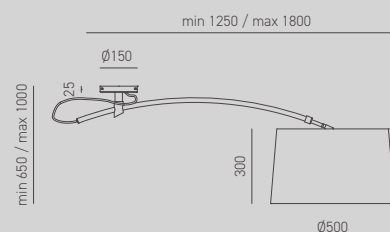
**AIDA S/P**

Socket: **1xE27**
 Power: **max 60W**
 Input: **220/240V**
 Pack: **0,052 m³**

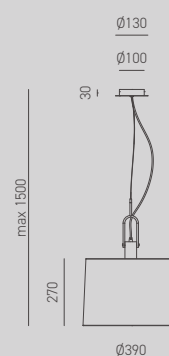
**AIDA S/G**

Socket: **1xE27**
 Power: **max 60W**
 Input: **220/240V**
 Pack: **0,092 m³**

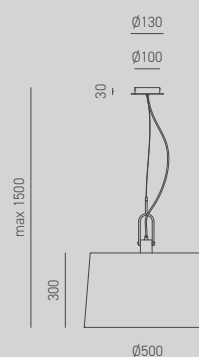

FINISHING

 Cromo - Bianco / Chrome - White

 Cromo - Nero / Chrome - Black



SUELO

Scenari emozionanti, di sicura atmosfera, garantiti dal peculiare paralume rivestito che cela il suo diffusore.

Suelo è la sontuosa lampada da pavimento che arreda ogni ambiente con classe innata, affermando comunque la sua indole moderna attraverso la struttura in cromo regolabile in altezza /

The special lampshade covered that conceals its diffuser guarantees delightful scenarios and a safe atmosphere.

Suelo is the sumptuous floor lamp that furnishes any environment with innate class while affirming its modern character through the height-adjustable chrome structure.





TECHNICAL INFORMATION



Piantana in metallo con finiture
bianco satinato e cromo
o nero satinato e cromo.
Altezza del fusto regolabile.
Paralume in tessuto bianco
con paralume nero trasparente.
Lampadine non incluse /
Metal floor lamp with satin white
and chrome or satin black and chrome
finishes. Height-adjustable stem.
Lampshade in white fabric with
transparent black lampshade.
Bulbs not included.

**SUELO PT**

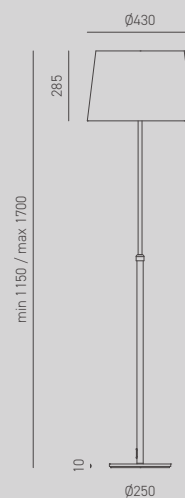
Socket: **1xE27**
Power: **max 60W**
Input: **220/240 Volt**
Pack: **0,098 m³**



FINISHING

-  Bianco satinato / Cromo
Satin white / Chrome
-  Nero satinato / Cromo
Black satin / Chrome



VITA

Progettata per essere collocata in ambiti ristretti e nei comodini della zona notte, Vita è la serie di lampade con paralume dalla forma ovale con dimensioni non invasive, perfetta per arredare la tua casa.

Declinata nelle varianti piantana, lume e applique risulta la soluzione smart ideale in ogni contesto stilistico e di spazio /

Designed to be placed in confined spaces and on bedside tables, Vita is a series of lamps featuring oval-shaped lampshades with dimensions that do not overwhelm a space, perfect for illuminating your home. Available in the floor lamp, table lamp and wall lamp variants, it is the ideal smart solution in any stylistic and spatial context.





TECHNICAL INFORMATION

Piantana, lume ed applique con montatura in metallo con finitura cromo.

Paralume in tessuto bianco.

Lampadine non incluse./

Floor lamp, lamp and wall lamp with metal frame

with chrome finish.

Lampshade in white fabric.

Bulbs not included.

**VITA A**

Socket: **1xE27**
 Power: **max 60W**
 Input: **220/240V**
 Pack: **0,023 m³**

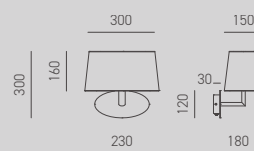
**VITA L**

Socket: **1xE27**
 Power: **max 60W**
 Input: **220/240V**
 Pack: **0,026 m³**

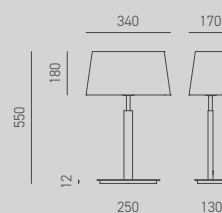
**VITA PT**

Socket: **1xE27**
 Power: **max 60W**
 Input: **220/240 Volt**
 Pack: **0,068 m³**

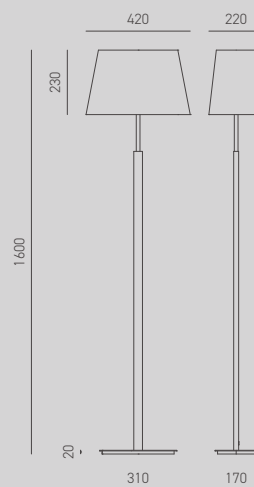

FINISHING

 Cromo / Chrome



TARA

L'elegante sostegno disegnato a laser dona un elemento di prestigio alla collezione generando una struttura ricercata e versatile.

Il particolare meccanismo snodato permette di orientare il paralume a piacimento conferendo uno stile informale, ma mai banale, all'apparecchio / The elegant laser-designed support confers a prestigious element to the collection, evoking a sophisticated and versatile structure.

Tara's special articulated mechanism allows you to orient the lampshade to your liking, conferring a relaxed mood that is never dull.





TECHNICAL INFORMATION

Piantana e lume con montatura in metallo con finiture bianco satinato e cromo o nero satinato e cromo.

Altezza del fusto regolabile.

Paralume inclinabile in tessuto bianco.

Lampadine non incluse /

Floor lamp and lamp with metal frame with satin white and chrome or black satin and chrome finishes.

Height-adjustable stem.

Tilting lampshade in white fabric.

Bulbs not included.

**TARA L**

Socket: **1xE27**
 Power: **max 60W**
 Input: **220/240V**
 Pack: **0,023 m³**

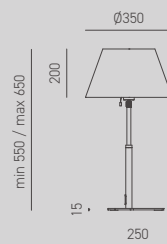
**TARA PT**

Socket: **1xE27**
 Power: **max 60W**
 Input: **220/240 Volt**
 Pack: **0,090 m³**

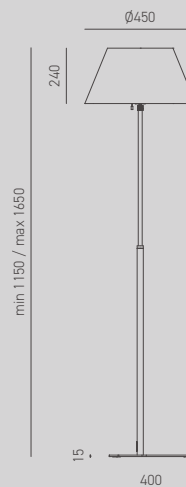

FINISHING

 Bianco satinato / Cromo
 Satin white / Chrome

 Nero satinato / Cromo
 Black satin / Chrome



VELIA

Un'illuminazione arcaica per stile, forme e materiali torna a essere moderna ed attuale in questa linea, grazie ad un'inusuale interpretazione stilistica. Rigorosi tratti lineari a sezione rettangolare disegnano struttura e diffusore dando vita al connubio perfetto tra design e luce /

The archaic style, shapes and materials of the lighting solution are renewed through an unusual stylistic interpretation, creating a modern and current series. The structure and diffuser are strictly linear, with a rectangular section, creating the perfect combination of design and light.





TECHNICAL INFORMATION

Piantana, lume ed applique
con montatura in metallo
con finitura bianco satinato.
Paralume in tessuto bianco.
Lampadine non incluse./
Floor lamp, lamp and wall lamp with
metal frame
with satin white finish.
Lampshade in white fabric.
Bulbs not included.

**VELIA A**

Socket: **1xE27**
Power: **max 60W**
Input: **220/240V**
Pack: **0,016 m³**

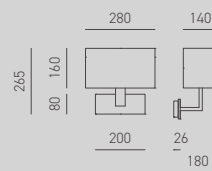
**VELIA L**

Socket: **1xE27**
Power: **max 60W**
Input: **220/240V**
Pack: **0,032 m³**

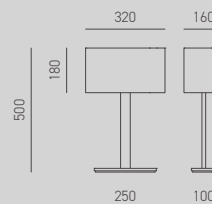
**VELIA PT**

Socket: **1xE27**
Power: **max 60W**
Input: **220/240 Volt**
Pack: **0,069 m³**

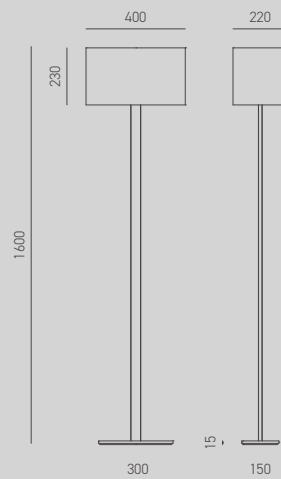

FINISHING

 Bianco Satinato / Satin White





ADELA

Ancora oggi lo stile "industrial" è uno dei design più amati, soprattutto quando si tratta di arredare casa con un tocco di energia e vitalità ispirato da dettagli vintage. Adela rievoca linee di altri tempi /

"Industrial" style is still one of the most popular designs today, especially when it comes to furnishing the home with a touch of energy and vitality inspired by vintage details. Adela evokes lines from times gone by.





TECHNICAL INFORMATION

Piantana ed applique con montatura in metallo regolabile con finitura cromo ed alluminio spazzolato.

Paralume in tessuto bianco.

Lampadine non incluse./

Floor lamp and wall lamp with adjustable metal frame with chrome and brushed aluminium finish.

Lampshade in white fabric.

Bulbs not included.

**ADELA A**

Socket: **1xE27**
 Power: **max 60W**
 Input: **220/240V**
 Pack: **0,036 m³**

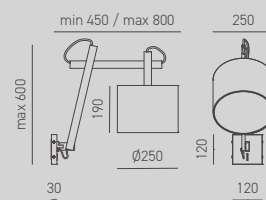
**ADELA PT**

Socket: **1xE27**
 Power: **max 60W**
 Input: **220/240 V**
 Pack: **0,111 m³**

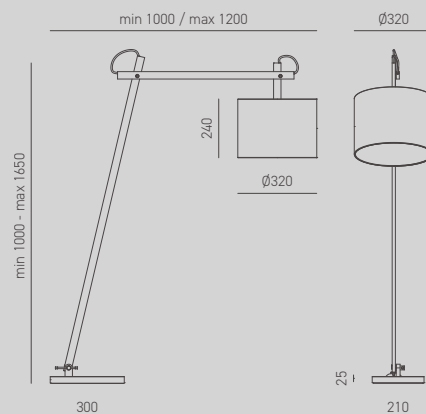

FINISHING



Cromo / Alluminio spazzolato
 Chrome / Brushed Aluminium

CORA

Una sospensione dalle sembianze minute, raccolte, ma densa di carisma. Il suo delicato piatto in vetro curvo lascia splendere e brillare una globolux a filamenti led, esaltata dai due sofisticati abbinamenti cromatici: il vetro ambra trasparente della versione in ottone spazzolato e il vetro fumè trasparente della variante in acciaio spazzolato / Cora is a pendant lamp with a minute, cosy appearance that reeks of charisma. Its delicate curved glass plate enhances the glistening, beaming globolux bulb featuring LED filaments. Cora is enhanced by two sophisticated colour combinations: a version with transparent amber glass and brushed brass and a variant with smoked transparent glass and brushed steel.







TECHNICAL INFORMATION

Sospensione con montatura in ferro.

Finiture: Ottone con diffusore in vetro trasparente ambrato; Silver con diffusore in vetro fumè trasparente.

Lampadine non incluse./

Suspension lighting with iron frame.

Finishes: Brass with transparent amber glass diffuser; Silver with transparent smoked glass diffuser.



Bulbs not included.

**CORA S**

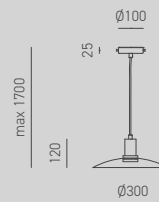
Socket: **1xE27**
 Power: **max 40W**
 Input: **220/240V**
 Pack: **0,018 m³**



GLASSES

-  Ambrato / Amber
-  Fumè / Smoked



ELBA ESTER

Forme essenziali esaltate dalla cura estrema delle finiture. Due sospensioni in vetro soffiato trasparente, sfumato bianco nella parte superiore: una lavorazione particolarissima che rende preziosa e unica questa serie che si identifica in ELBA per il diffusore ovale e Ester per quello sferico /

The incredibly detailed finishes enhance the minimalist shapes. Two pendant lamps in transparent blown glass, featuring a white gradient in the upper section; the extraordinary processing technique makes this series precious and unique. The oval diffuser identifies Elba, while Ester features a spherical one.





TECHNICAL INFORMATION

Sospensione con montatura in metallo satinato bianco.

Diffusore in vetro bianco sfumato.

Lampadina non inclusa; misura massima della lampadina diam. 60mm./

Suspension with satin white metal frame.

Frosted white glass diffuser.

Bulb not included; maximum bulb size 60 mm diameter.

**ELBA S**

Socket: **1xE27**
 Power: **max 40W**
 Input: **220/240V**
 Pack: **0,133 m³**

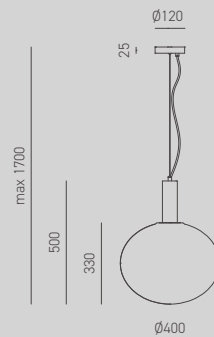
**ESTER S**

Socket: **1xE27**
 Power: **max 40W**
 Input: **220/240V**
 Pack: **0,097 m³**

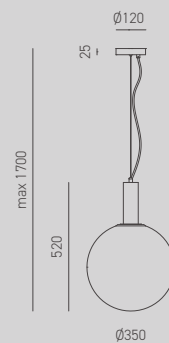

GLASSES



Bianco Satinato / Satin White





SFERA

Forme geometriche perfette danzano in un gioco di altezze e materia generando un design unico e personalizzabile. Una collezione definita da più elementi che compongono delle sospensioni ben strutturate, da collocare a diverse sommità, in cui ogni punto luce si caratterizza per un elemento in materiale cementizio e un diffusore sottostante in vetro borosilicato, soffiato, bianco opaco. Evoluzione continua / Perfect geometric shapes intermingle in a play of varying heights and materials, creating a unique and customisable design. Sfera is a collection defined by several elements that compose well-structured pendant lamps, to be positioned at different heights. Each light point is characterised by an element in cementitious material and an underlying diffuser in opaque white borosilicate blown glass. Continuous evolution







TECHNICAL INFORMATION



Sospensione con montatura in metallo satinato bianco. Diffusore in vetro opale agganciato ad una sfera di cemento con finitura grigio chiaro, grigio scuro o rosso. Lampadina non inclusa. Misura massima della lampadina diam. 19 mm / Suspension with satin white metal frame. Opal glass diffuser attached to a concrete sphere with light grey, dark grey or red finish. Bulb not included. Maximum bulb size 19 mm diameter.

**SFERA S**

Socket: **1xG9**
 Power: **max 28W (max 7W led)**
 Input: **220/240V**
 Pack: **0,007 m³**



FINISHING

-  Grigio chiaro / Light grey
-  Grigio scuro / Dark grey
-  Rosso / Red

Sospensione con montatura in metallo satinato bianco. Diffusore in vetro opale agganciato ad una sfera di cemento. Finitura: 2 sfere grigio chiaro, 2 sfere grigio scuro e 2 sfere rosso. Lampadine non incluse / Suspension with satin white metal frame. Opal glass diffuser attached to a concrete sphere. Finish: 2 light grey spheres, 2 dark grey spheres and 2 red spheres. Bulbs not included.

**SFERA S/6**

Socket: **6xG9**
 Power: **max 6x28W (max 6x7W led)**
 Input: **220/240V**
 Pack: **0,048 m³**

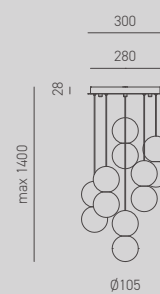

Sospensione con montatura in metallo satinato bianco. Diffusore in vetro opale agganciato ad una sfera di cemento. Finitura: 3 sfere grigio chiaro, 4 sfere grigio scuro e 3 sfere rosso. Lampadine non incluse / Suspension with satin white metal frame. Opal glass diffuser attached to a concrete sphere. Finish: 3 light grey spheres, 4 dark grey spheres and 3 red spheres. Bulbs not included.

**SFERA S/10**

Socket: **10xG9**
 Power: **max 10x28W (max 10x7W led)**
 Input: **220/240V**
 Pack: **0,103 m³**

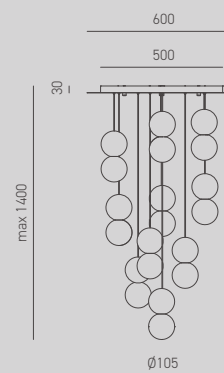



CLEOFE

Eclettica nello stile, certamente raffinata nei toni e nella scelta dei colori. Una vera cascata di luci e forme differenti accomunate da una particolare lavorazione artistica del vetro con la decorazione in rilievo sviluppata a spina di pesce. Tre i diffusori presentati declinabili nelle quattro splendide colorazioni del vetro /

Stylistically eclectic, Cleofe is certainly sophisticated in the tones and range of colours. A true cascade of varying lights and shapes united by a special artistic processing technique, where the glass is decorated with a herringbone pattern in relief. Three glass diffusers are presented, which can be expressed in four splendid colours.















TECHNICAL INFORMATION

Sospensioni con montatura in metallo.
 Finiture: Metallo bianco opaco con vetro bianco opale; Metallo nero opaco con vetro cobalto trasparente; Metallo ottone con vetro ambra trasparente; Metallo cromo con vetro ocra trasparente.
 Lampadine non incluse./
 Suspension lighting with metal frame.
 Finishes: Matt white metal with opal white glass; Matt black metal with transparent cobalt glass; Brass metal with transparent amber glass; Chrome metal with transparent ochre glass. Bulbs not included.

**CLEOFE S/10**

Socket: **1xE27**
 Power: **max 60W**
 Input: **220/240V**
 Pack: **0,035 m³**

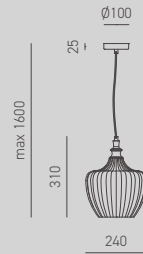
**CLEOFE S/11**



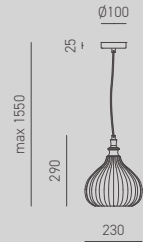

Socket: **1xE27**
 Power: **max 60W**
 Input: **220/240V**
 Pack: **0,028 m³**

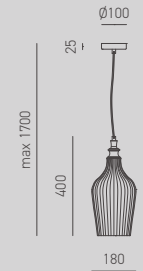
**CLEOFE S/12**





Socket: **1xE27**
 Power: **max 60W**
 Input: **220/240V**
 Pack: **0,025 m³**



FINISHING

-  Bianco Opaco / White Matt
-  Nero Opaco / Black Matt
-  Ottone / Brass
-  Cromo / Chrome

GLASSES

-  Bianco Opale / Opal White
-  Cobalto / Cobalt
-  Ambra Trasparente / Transparent Amber
-  Ocra / Ochre

TECHNICAL INFORMATION

Sospensioni con montatura in metallo.

Finiture: Metallo bianco opaco con vetri bianco opale; Metallo ottone con vetri ambra trasparente; Metallo nero opaco con 1 vetro ambra trasparente, 1 vetro ocra ed 1 vetro cobalto.

Lampadine non incluse./

Suspension lighting with metal frame.

Finishes: Matt white metal with opal white glass; Brass metal with transparent amber glasses; Matt black metal with 1 transparent amber glass, 1 ochre glass and 1 cobalt glass.

Bulbs not included.

**CLEOFE S/3**

Socket: **3xE27**
 Power: **max 3x60W**
 Input: **220/240V**
 Pack: **0,142 m³**



Sospensioni con montatura in metallo.

Finiture: Metallo bianco opaco con vetri bianco opale; Metallo ottone con vetri ambra trasparente; Metallo nero opaco con 2 vetri ambra trasparente, 2 vetri ocra e 2 vetri cobalto.

Lampadine non incluse./

Suspension lighting with metal frame.

Finishes: Matt white metal with opal white glass; Brass metal with transparent amber glass; Matt black metal with transparent amber glass x 2, ochre glass x 2 and cobalt glass x 2.



Bulbs not included.

**CLEOFE S/6**

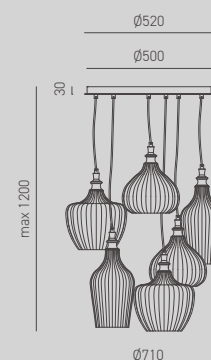



Socket: **6xE27**
 Power: **max 6x60W**
 Input: **220/240V**
 Pack: **0,251 m³**



FINISHING

-  Bianco Opaco / White Matt
-  Ottone / Brass
-  Nero Opaco / Black Matt

GLASSES

-  Bianco Opale / Opal White
-  Ambra Trasparente / Transparent Amber
-  Ocra / Ochre
-  Cobalto / Cobalt
-  Ambra Trasparente / Transparent Amber



AURELIA AZZURRA ASMARA

Esclusività ed estro in queste peculiari sospensioni composte da tre diffusori in vetro disponibili in altrettante tre colorazioni: trasparente, ambra e fumè. L'estrema versatilità delle montature permette installazioni singole e multiple, che grazie a speciali kit, consentono di dare libero sfogo alla creatività in infinite composizioni /

These unique pendant lamps express exclusivity and inspiration. They are composed of three glass diffusers available in as many colour variations: transparent, amber and smoked. The extreme versatility of the frames allows you to create single and multiple installations. The special kits give you free rein to explore infinite compositions.



KIT SOSPENSIONI MULTIPLE

il loro punto forte è la versatilità e la semplicità di installazione, permettono svariati tipi di conformazione grazie ai 3 metri di cavo e agli accessori dedicati /

KIT FOR MULTIPLE COMPOSITIONS

The versatility and the simplicity of installation is the main strength of the kits, which allow you to accomplish various configurations thanks to the 3 mt cable and the dedicated accessories.







Sospensione lineare a 3 luci nella
composizione tradizionale.
Nella pagina accanto installazione
con estensione laterale di uno
o più punti luce /
Linear suspension with 3 lights
in a traditional configuration.
On the opposite page: installation
with a lateral extension of
one or more light points.



Esempio d'ordine: **GSTB041** n.1 + **Azzurra V/1 Ambra** n.1 + **Aurelia V/1 Ambra** n.1 + **Asmara V/1 Ambra** n.1
Order exampe: **GSTB041** n.1 + **Azzurra V/1 Amber** n.1 + **Aurelia V/1 Amber** n.1 + **Asmara V/1 Amber** n.1





Sospensione circolare a 3 luci
nella composizione a grappolo
con estensione laterale di uno
o più punti luce. Nella pagina
accanto con installazione nella
versione a parete/soffitto /
Circular suspension with 3
lights in a cluster configuration
with a lateral extension of one
or more light points. On the
opposite page: installation of
the wall/ceiling version



Esempio d'ordine: **GSOB31** n.1 + **GSOBL11** n.2 + **Asmara V/1 Fumè** n.3
Order exampe: **GSOB31** n.1 + **GSOBL11** n.2 + **Asmara V/1 Smoked** n.3





Sospensione circolare a 5 luci
nella composizione da soffitto a
grappolo. Nella pagina accanto
composizione con installazione
decentrata con estensione
laterale di più punti luce /
Circular suspension with 5
lights in a cluster configuration.
Opposite page: configuration
with a decentralised installation
featuring a lateral extension of
several light points.



Esempio d'ordine: **GSOB51** n.1 + **GSOBL11** n.5 + **Azzurra V/1 Ambra** n.5

Order exampe: **GSOB51** n.1 + **GSOBL11** n.5 + **Azzurra V/1 Amber** n.5





Sospensione circolare a 12 luci
nella composizione simmetrica
a filo muro e nella pagina
seguinte una composizione
asimmetrica e libera con luci a
richiesta /

Circular flush suspension
lamp with 12 lights in a
symmetrical configuration,
and on the following page
an asymmetrical and
free configuration with a
customisable number of lights.



Esempio d'ordine: **GSOB02** n.1 + **GSOBL02** n.12 + **Aurelia V/1 Trasparente** n.12

Order exampe: **GSOB02** n.1 + **GSOBL02** n.12 + **Aurelia V/1 Transparent** n.12



TECHNICAL INFORMATION

Sospensioni con montatura in metallo nero satinato e diffusore in vetro ambra, fumè o trasparente.

Lampadine non incluse /

Suspension lighting with satin black metal frame and amber, smoked or transparent glass diffuser.
Bulbs not included.

**ASMARA S/1**

Socket: **1xE27**
Power: **max 40W**
Input: **220/240V**
Pack: **0,019 m³**

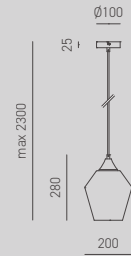
**AURELIA S/1**

Socket: **1xE27**
Power: **max 40W**
Input: **220/240V**
Pack: **0,015 m³**

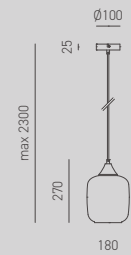
**AZZURRA S/1**

Socket: **1xE27**
Power: **max 40W**
Input: **220/240V**
Pack: **0,015 m³**

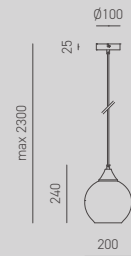

Sospensioni senza rosoni dotati di cavo elettrico lunghezza 3m e diffusore in vetro ambra, fumè o trasparente.

Lampadine non incluse./

Suspension lighting without canopy equipped with 3m electric cable and amber, smoked or transparent glass diffuser.

**ASMARA V/1**

Socket: **1xE27**
Power: **max 40W**
Input: **220/240V**
Pack: **0,019 m³**

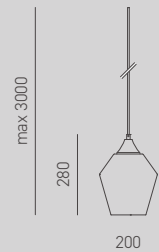
**AURELIA V/1**

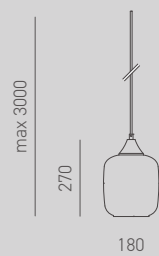

Socket: **1xE27**
Power: **max 40W**
Input: **220/240V**
Pack: **0,015 m³**

**AZZURRA V/1**

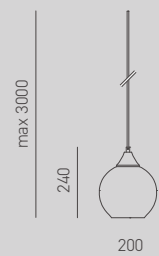
Socket: **1xE27**
Power: **max 40W**
Input: **220/240V**
Pack: **0,015 m³**



GLASSES

-  Ambra / Amber
-  Fumè / Smoked
-  Trasparente / Transparent

TECHNICAL INFORMATION

Rosone rettangolare a tre fori in metallo nero con staffa ed accessori per il fissaggio inclusi. Compresi tre pressacavi e morsettiera elettrica./

Three-hole, rectangular black metal canopy with bracket and fixing accessories included. Includes three cable glands and electrical terminal block.

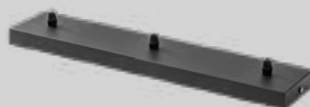

GSOB41

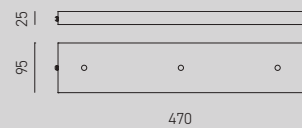

Rosone a tre fori in metallo nero con staffa ed accessori per il fissaggio inclusi. Compresi tre pressacavi e morsettiera elettrica./

Three-hole black metal canopy with bracket and fixing accessories included. Includes three cable glands and electrical terminal block.



GSOB31

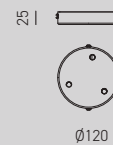

Rosone a cinque fori in metallo nero con staffa ed accessori per il fissaggio inclusi. Compresi cinque pressacavi e morsettiera elettrica./

Five-hole black metal canopy with bracket and fixing accessories included. Includes five cable glands and electrical terminal block.



GSOB51

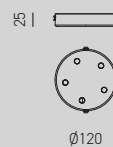

Rosone a dodici fori in metallo nero con staffa ed accessori per il fissaggio inclusi. Compresi dodici pressacavi e morsettiera elettrica./

Black metal canopy with twelve lateral holes, includes bracket and fixing accessories. Twelve cable glands and electrical terminal blocks included.



GSOB02

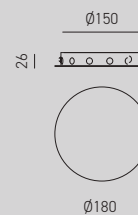

Decentratore in metallo nero con aggancio e fissaggio con grano per cavi elettrici./

Black metal decentralizations with hook and dowel fitting for electric cables.



GSOBL11



Decentratore in metallo nero con regolazione per cavi elettrici./

Black metal decentralizations with adjustment for electric cables.



GSOBL02







CESIRA

Cesira è la sospensione singola dall'aspetto distinto e casto, proposta in tre differenti nature: tonda, ovale orizzontale e ovale verticale. Luce soffusa, superficie in vetro lavorato in due eleganti colorazioni fumè con un bellissimo effetto specchio, oppure con la virtuosa finitura lucida bianco latte.

Piacere per gli occhi /

Cesira is a single pendant lamp defined by its distinct and pure appearance. It is available in three different formats: round, horizontal oval and vertical oval. Soft light shines through glass surfaces created in two elegant colours; smoky with a beautiful mirror effect, and the virtuous milky white glossy finish. A pleasure for the eyes.



Gealuce / Cesira





TECHNICAL INFORMATION

Sospensioni con montatura in metallo.
 Finiture sospensioni singole: Metallo
 bianco opaco con vetro bianco opale;
 Metallo nero opaco con vetro grigio fumè.
 Finiture sospensioni multiple: Metallo
 bianco opaco con vetri bianco opale;
 Metallo nero opaco con vetri grigio fumè.
 Lampadine non incluse./

Suspension lighting with metal frame.
 Single suspension lighting finishes: Matt
 white metal with opal white glass;
 Matt black metal with smoked grey glass.
 Multiple suspension finishes: Matt white
 metal with opal white glass;
 Matt black metal with smoked grey glass.
 Bulbs not included.

**CESIRA S/10**

Socket: **1xE27**
 Power: **max 60W**
 Input: **220/240V**
 Pack: **0,033 m³**

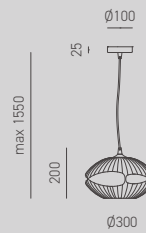
**CESIRA S/11**

Socket: **1xE27**
 Power: **max 60W**
 Input: **220/240V**
 Pack: **0,042 m³**

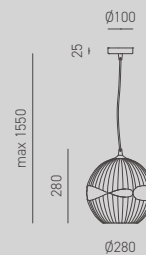
**CESIRA S/12**

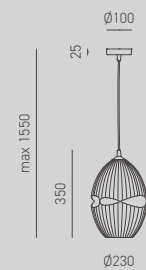

Socket: **1xE27**
 Power: **max 60W**
 Input: **220/240V**
 Pack: **0,036 m³**

**CESIRA S/3**

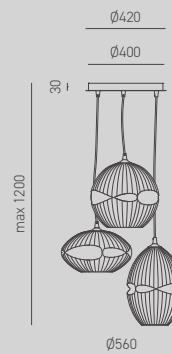
Socket: **3xE27**
 Power: **max 3x60W**
 Input: **220/240V**
 Pack: **0,192 m³**



GLASSES

-  Bianco Opale / Opal White
-  Grigio Fumè / Smoked Grey







PENELOPE

Volumi che si scompongono, si intrecciano. un tocco estetico che non distrae dalle raffinate rifiniture del cromo e del vetro bianco / Shapes that deconstruct and integrate. An aesthetic detail that does not distract from refined chrome and white glass finishes.







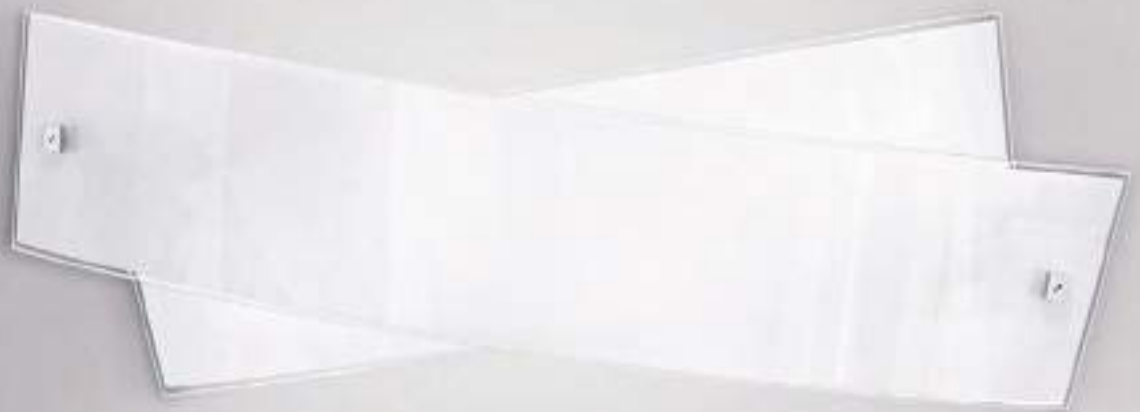



TECHNICAL INFORMATION

Montatura in metallo con finitura cromo per lumetto e sospensioni. Montatura in metallo bianco per applique e plafoniere. Diffusore in vetro bianco con finitura lucida / Metal fitting with chrome finish for table and suspension lamps. White painted metal fitting for wall, ceiling and lamps. White glass diffuser with gloss finish.

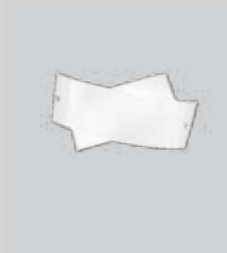
**PENELOPE A/P**

Socket: **2xE14**
 Power: **max 2x28W**
 Input: **220/240V**
 Pack: **0,013 m³**

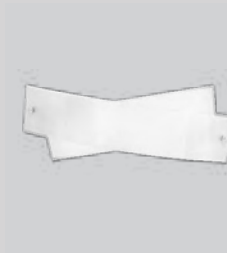
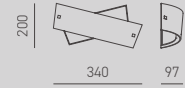
**PENELOPE A/M**

Socket: **4xE14**
 Power: **max 4x28W**
 Input: **220/240V**
 Pack: **0,025 m³**

**PENELOPE L**

Socket: **1xE14**
 Power: **max 42W**
 Input: **220/240V**
 Pack: **0,013 m³**

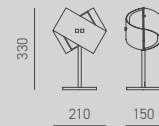
**PENELOPE P/P**

Socket: **3xE14**
 Power: **max 3x28W**
 Input: **220/240V**
 Pack: **0,022 m³**

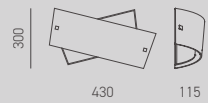
**PENELOPE P/M**

Socket: **2xE27**
 Power: **max 2x70W**
 Input: **220/240V**
 Pack: **0,046 m³**

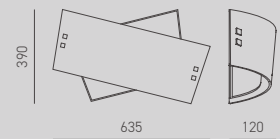

GLASSES

 Bianco / White

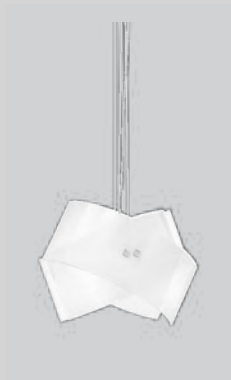

PENELOPE S/M

Socket: **2xE27**
 Power: **max 2x52W**
 Input: **220/240V**
 Pack: **0,032 m³**

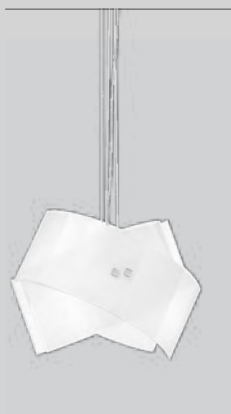
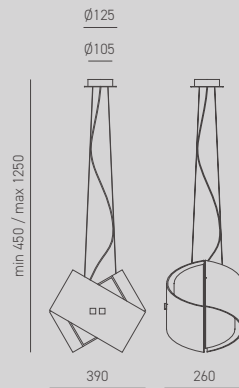

PENELOPE S/G

Socket: **2xE27**
 Power: **max 2x70W**
 Input: **220/240V**
 Pack: **0,058 m³**

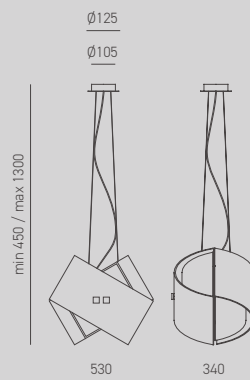

AGNESE

Le decorazioni tribal con dettagli bianchi regalano un contrasto ottimale con gli spazi più raffinati. Il lume da tavolo è ideale per la zona tv o l'area notte /

Tribal decorations with white details provide an excellent contrast with more refined spaces.

The ideal table lamp for the tv area or night area.

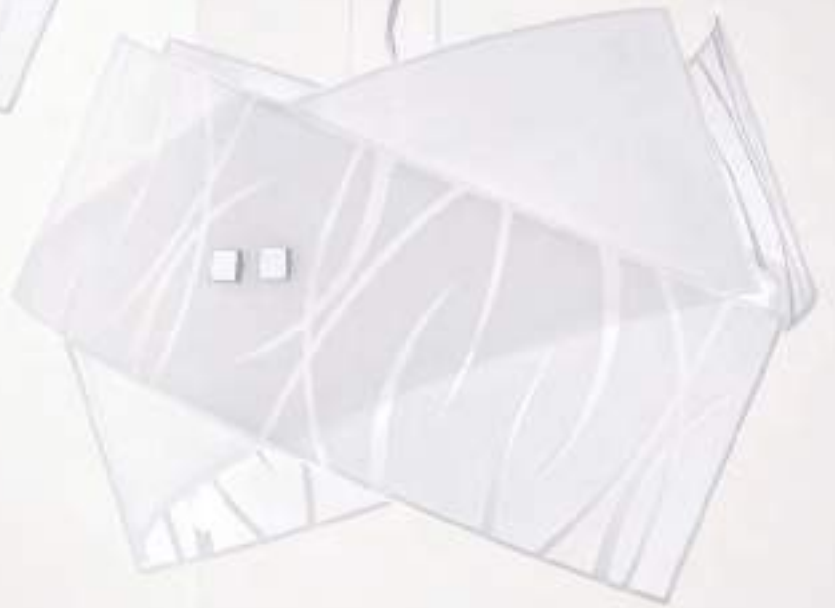









TECHNICAL INFORMATION

Montatura in metallo con finitura cromo per lumetto e sospensioni.

Montatura in metallo bianco per applique e plafoniere. Diffusore con vetro serigrafato e decorato bianco.

Finitura satinata /

Metal fitting with chrome finish for table and suspension lamps.

White painted metal fitting for wall, ceiling and lamps. Diffuser with white silk screen printed and decorated glass Satin finish.

**AGNESE A/P**

Socket: **2xE14**
Power: **max 2x28W**
Input: **220/240V**
Pack: **0,013 m³**

**AGNESE A/M**

Socket: **4xE14**
Power: **max 4x28W**
Input: **220/240V**
Pack: **0,025 m³**

**AGNESE L/P**

Socket: **1xE14**
Power: **max 42W**
Input: **220/240V**
Pack: **0,013 m³**

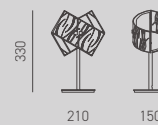
**AGNESE P/P**

Socket: **3xE14**
Power: **max 3x28W**
Input: **220/240V**
Pack: **0,022 m³**

**AGNESE P/M**

Socket: **2xE27**
Power: **max 2x70W**
Input: **220/240V**
Pack: **0,046 m³**

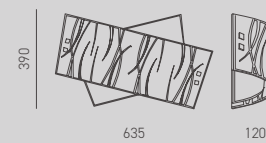

GLASSES

 Bianco / White



AGNESE S/M

Socket: **2xE27**
 Power: **max 2x52W**
 Input: **220/240V**
 Pack: **0,032 m³**

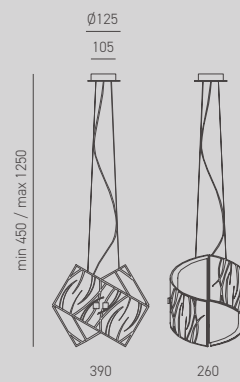

AGNESE S/G

Socket: **2xE27**
 Power: **max 2x70W**
 Input: **220/240V**
 Pack: **0,058 m³**

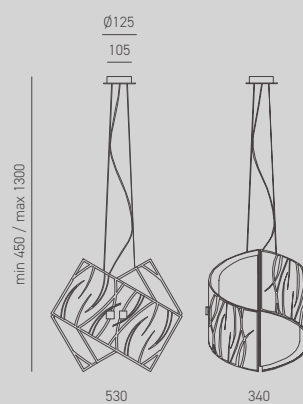



CAMILLA

In Camilla, la libertà di formato si sposa con la ricercatezza delle fasce dominanti, decorate con foglia oro e argento /

The free shape of camilla perfectly accompanies refined predominant bands, decorated with gold and silver leaf.









TECHNICAL INFORMATION

Montatura in metallo con finitura cromo per lumetto e sospensioni.

Montatura in metallo bianco per applique e plafoniere. Diffusore con vetri colorati foglia oro o foglia argento.

Finitura lucida /

Metal fitting with chrome finish for table and suspension lamps.

White painted metal fitting for wall and ceiling. Diffuser with colour glass, gold or silver leaf. Gloss finish.

**CAMILLA A/P**

Socket: **2xE14**
 Power: **max 2x28W**
 Input: **220/240V**
 Pack: **0,013 m³**

**CAMILLA A/M**

Socket: **4xE14**
 Power: **max 4x28W**
 Input: **220/240V**
 Pack: **0,025 m³**

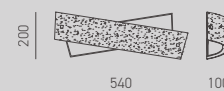
**CAMILLA L/P**

Socket: **1xE14**
 Power: **max 42W**
 Input: **220/240V**
 Pack: **0,013 m³**

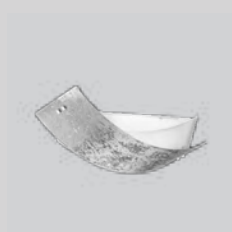
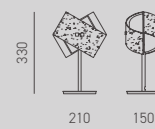
**CAMILLA P/P**

Socket: **3xE14**
 Power: **max 3x28W**
 Input: **220/240V**
 Pack: **0,022 m³**

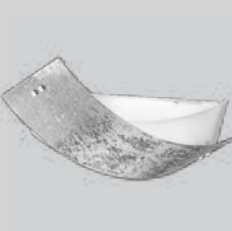
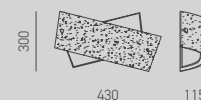
**CAMILLA P/M**

Socket: **2xE27**
 Power: **max 2x70W**
 Input: **220/240V**
 Pack: **0,046 m³**

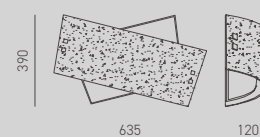
**CAMILLA S/G**

Socket: **2xE27**
 Power: **max 2x70W**
 Input: **220/240V**
 Pack: **0,058 m³**

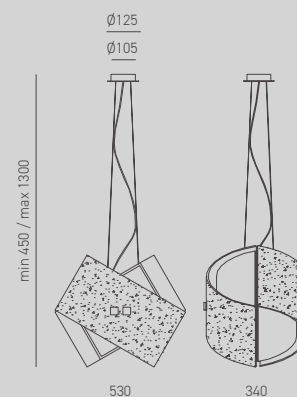

FINISHING

 Foglia Oro / Gold Leaf

 Foglia Argento / Silver Leaf





LARA

Una sovrapposizione geometrica e cromatica dall'appeal moderno e ricercato. spazio al colore, agli abbinamenti, alla particolarità / Overlapping shapes and colours with refined modern appeal. A focus on colour, combinations and detail.







TECHNICAL INFORMATION

Montatura in metallo con finitura cromo.
 Diffusore in vetro bianco con particolari
 foglia oro o foglia argento./
 Metal fitting with chrome finish. White
 glass with gold or silver leaf coloured
 glass. Polish finish.

**LARA A/P**

Socket: **2xE14**
 Power: **max 2x42W**
 Input: **220/240V**
 Pack: **0,012 m³**

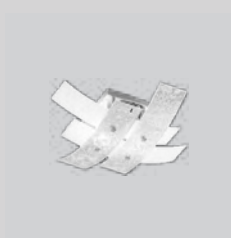
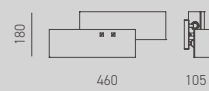
**LARA P/P**

Socket: **2xE27**
 Power: **max 2x52W**
 Input: **220/240V**
 Pack: **0,024 m³**

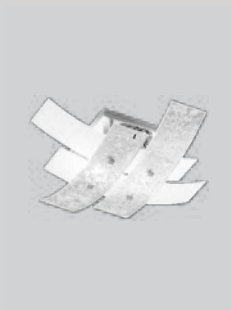
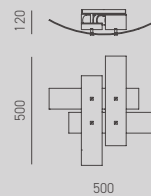
**LARA P/M**

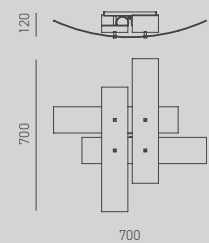

Socket: **2xE27**
 Power: **max 2x70W**
 Input: **220/240V**
 Pack: **0,035 m³**

**LARA P/G**

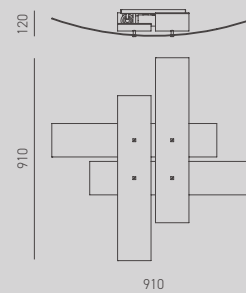
Socket: **4xE27**
 Power: **max 4x52W**
 Input: **220/240V**
 Pack: **0,06 m³**



FINISHING

-  Foglia Oro / Gold Leaf
-  Foglia Argento / Silver Leaf



FRIDA

Frida affascina per le trasparenze del vetro satinato ma la sua firma unica sono gli elementi centrali decorati da segni liberi /

Frida charms with its satined glass transparencies, yet its unique features are its central elements decorated with free-hand designs.

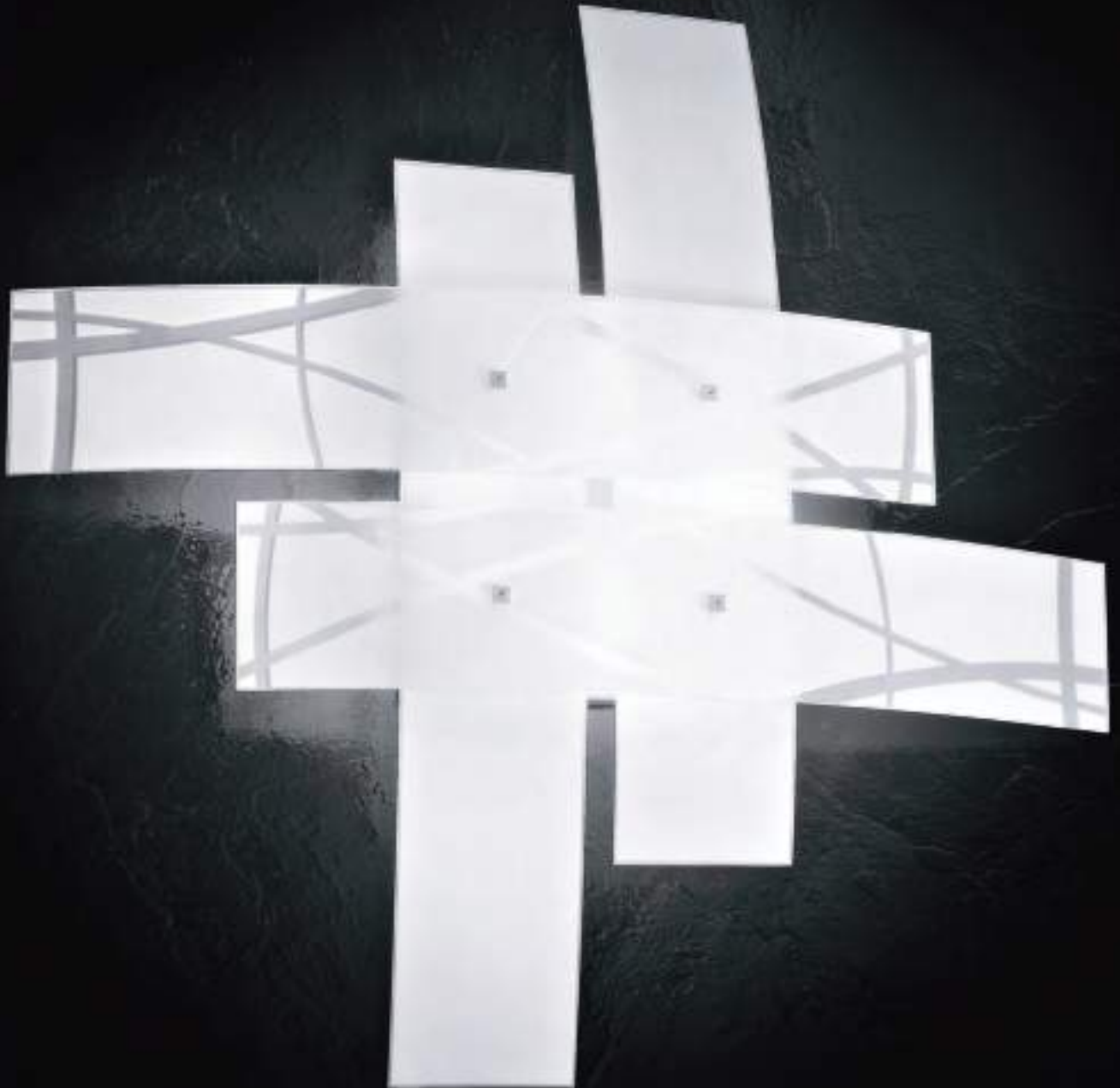







TECHNICAL INFORMATION

Montatura in metallo, finitura cromo.
 Vetri satinati e colorati in bianco.
 Finitura satinata./
 Metal fitting with chrome finish.
 Coloured and satined white glass.
 Matt finish.

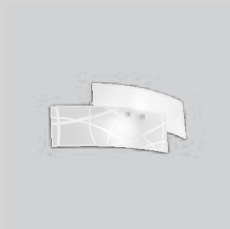
**FRIDA A/P**

Socket: **2xE14**
 Power: **max 2x42W**
 Input: **220/240V**
 Pack: **0,013 m³**

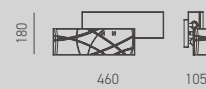
**FRIDA A/G**

Socket: **2xE14**
 Power: **max 2x42W**
 Input: **220/240V**
 Pack: **0,013 m³**

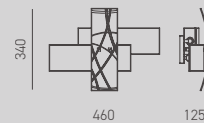
**FRIDA P/P**

Socket: **2xE27**
 Power: **max 2x52W**
 Input: **220/240V**
 Pack: **0,025 m³**

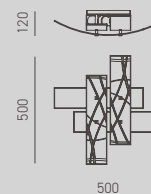
**FRIDA P/M**

Socket: **2xE27**
 Power: **max 2x70W**
 Input: **220/240V**
 Pack: **0,036 m³**

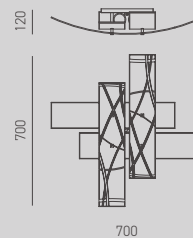
**FRIDA P/G**

Socket: **4xE27**
 Power: **max 4x52W**
 Input: **220/240V**
 Pack: **0,060 m³**

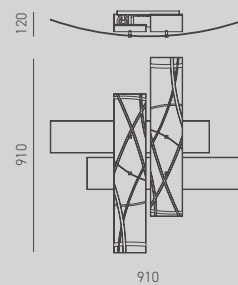

GLASSES

Bianco / White



NEREIDE

Il dolce intreccio di decori ornamentali compone l'amalgama ideale di questa eterea collezione composta da sospensione, plafoniera e applique. Unicità e forme convenzionali si intrecciano formando un'impeccabile equilibrio /

The sweet intertwining of ornamental decorations makes up the ideal blend of this ethereal collection consisting of pendant, ceiling and wall lamps. Uniqueness and conventional forms intertwine, forming an impeccable balance.









TECHNICAL INFORMATION

Montatura in metallo, particolari cromo.
 Diffusore in vetro serigrafato bianco.
 Finitura satinata./
 Chrome metal fitting. Etched satined
 white glass.
 Matt finish.

**NEREIDE A**

Socket: **2xE14**
 Power: **max 2x28W**
 Input: **220/240V**
 Pack: **0,01 m³**

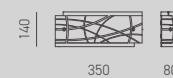
**NEREIDE P/P**

Socket: **2xE27**
 Power: **max 2x42W**
 Input: **220/240V**
 Pack: **0,018 m³**

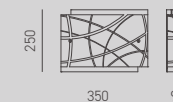
**NEREIDE P/M**

Socket: **2xE27**
 Power: **max 2x52W**
 Input: **220/240V**
 Pack: **0,026 m³**

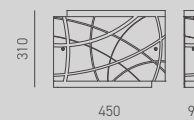
**NEREIDE S/M**

Socket: **2xE27**
 Power: **max 2x52W**
 Input: **220/240V**
 Pack: **0,046 m³**

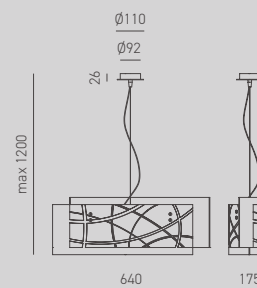
**NEREIDE L**

Socket: **1xE14**
 Power: **max 42W**
 Input: **220/240V**
 Pack: **0,018 m³**

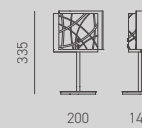

GLASSES

○ Bianco / White





DELIA

Delia da sempre riscontra un forte consenso per la semplicità e leggiadria delle eleganti decorazioni in oro, argento e cristallo che accompagnano la superficie di vetro in lastra serigrafata e curvata. Declinata nelle versioni sospensione, plafoniera e applique, in diverse dimensioni, risulta una collezione completa perfetta per valorizzare ogni ambiente /

Delia has always encountered a strong consensus for the simplicity and gracefulness of its elegant decorations in gold, silver and crystal, accompanying the curved screen-printed glass surface. Expressed in varying sizes in the pendant, ceiling and wall lamp versions, it is a complete collection that perfectly enhances any space.









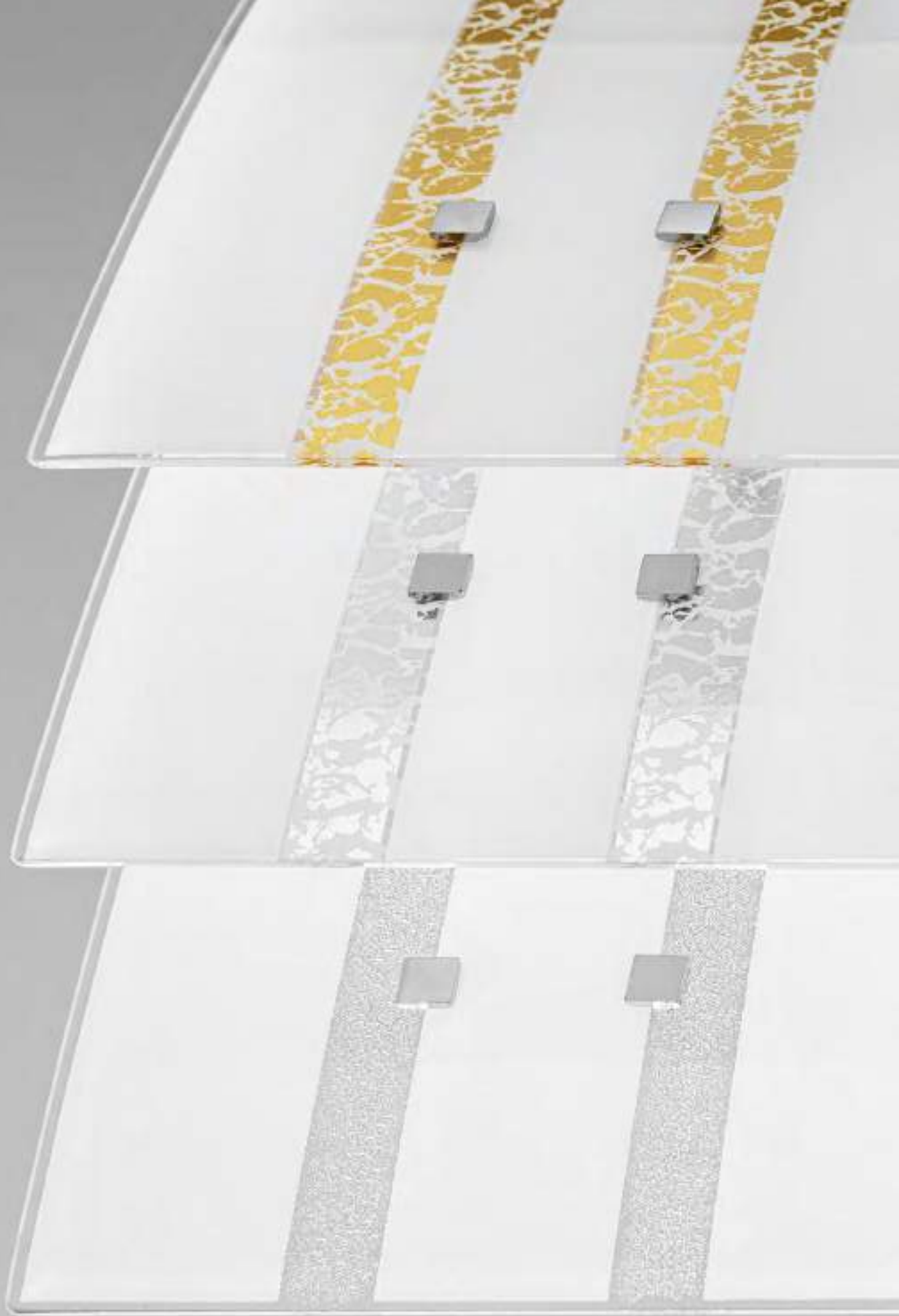

TECHNICAL INFORMATION

Montatura in metallo bianco.
 Diffusore in vetro bianco
 con particolari in cristallo bianco,
 argento o oro.
 Lampadine non incluse./
 White metal frame. White glass
 diffuser with details in white crystal,
 silver or gold.
 Bulbs not included.

**DELIA A**

Socket: **2xE14**
 Power: **max 2x28W**
 Input: **220/240V**
 Pack: **0,008 m³**
 Confezione 10 pezzi /
 Package 10 pieces

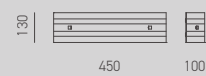
**DELIA P/P**

Socket: **1xE27**
 Power: **max 60W**
 Input: **220/240V**
 Pack: **0,011 m³**
 Confezione 5 pezzi /
 Package 5 pieces

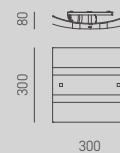
**DELIA P/G**

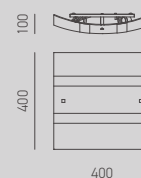

Socket: **2xE27**
 Power: **max 2x60W**
 Input: **220/240V**
 Pack: **0,021 m³**
 Confezione 5 pezzi /
 Package 5 pieces

**DELIA S**

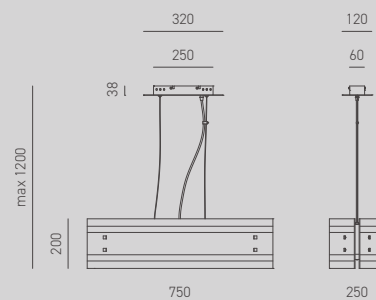
Socket: **4xE27**
 Power: **max 4x60W**
 Input: **220/240V**
 Pack: **0,056 m³**



GLASSES

-  Cristallo bianco / White crystal
-  Argento / Silver
-  Oro / Gold



MICHELA

Linee talmente semplici e regolari da risultare istintive, danno vita alle forme di questa lampada dall'aspetto conosciuto ma al contempo perfettamente in grado di creare un legame perpetuo tra luce e superfici. Michela è un classico senza tempo / Michela is instinctive, made up of such simple and regular lines, creating the shapes of this lamp defined by its easily recognisable appearance. At the same time, it is perfectly capable of creating an eternal bond between light and the surfaces on which it shines. Michela is a timeless classic.





TECHNICAL INFORMATION

Base in metallo, particolari cromo.
 Diffusore in vetro colorato bianco.
 Finitura lucida /
 Metal fitting with chrome finish.
 White coloured glass. Polish finish.

**MICHELA A/P**

Socket: **1xE27**
 Power: **max 42W**
 Input: **220/240V**
 Pack: **0,007 m³**

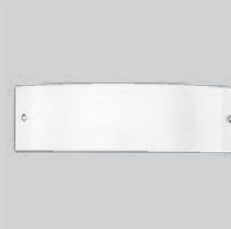
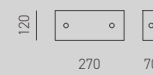
**MICHELA A/G**

Socket: **2xE14**
 Power: **max 2x28W**
 Input: **220/240V**
 Pack: **0,009 m³**

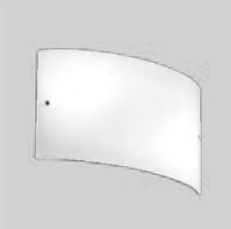
**MICHELA P/P**

Socket: **2xE27**
 Power: **max 2x42W**
 Input: **220/240V**
 Pack: **0,012 m³**

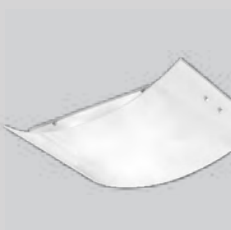
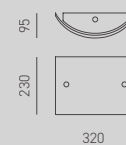
**MICHELA P/M**

Socket: **2xE27**
 Power: **max 2x52W**
 Input: **220/240V**
 Pack: **0,033 m³**

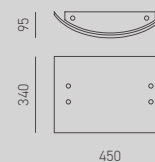

GLASSES



Bianco / White



LECCE

Pulizia estrema e pragmatismo ne plasmano il profilo trasparente. Lecce è una lampada perfetta per ogni soluzione d'arredo, sia essa classica o moderna, è in grado di decorare la casa ponendo un accento di luce delicato sull'ambiente che la accoglie / Immaculate lines and pragmatism shape Lecce's transparent profile. Lecce is the perfect lamp to furnish any style of interior, whether it is classic or modern. It decorates the home by casting a delicate accent of light over any space it is positioned.





TECHNICAL INFORMATION

Montatura in metallo, particolari cromo.
Vetro serigrafato bianco, finitura satinata / Chrome metal fitting.
Etched satined white glass.

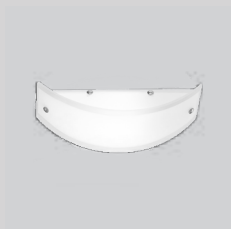
**LECCE A/P**

Socket: **1xE27**
Power: **max 42W**
Input: **220/240V**
Pack: **0,007 m³**

**LECCE A/G**

Socket: **2xE14**
Power: **max 2x28W**
Input: **220/240V**
Pack: **0,009 m³**

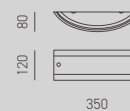
**LECCE P/P**

Socket: **2xE27**
Power: **max 2x42W**
Input: **220/240V**
Pack: **0,012 m³**

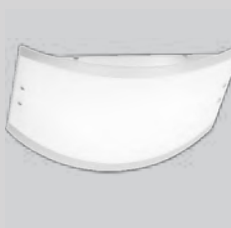
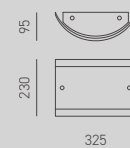
**LECCE P/M**

Socket: **2xE27**
Power: **max 2x52W**
Input: **220/240V**
Pack: **0,033 m³**

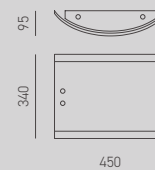

GLASSES



Bianco / White

Technical information index /

INDICE INFORMAZIONI TECNICHE

ACCESSORI

GSOB02	249
GSOB31	249
GSOB41	249
GSOB51	249
GSOBL02	249
GSOBL11	249

ADELA

ADELA A	211
ADELA PT	211

AGNESE

AGNESE A/P	272
AGNESE A/M	272
AGNESE L/P	272
AGNESE P/P	272
AGNESE P/M	272
AGNESE S/M	273
AGNESE S/G	273

AIDA

AIDA P/G	191
AIDA P/P	191
AIDA S/G	191
AIDA S/P	191

AMINA

AMINA S/G	55
AMINA S/M	55
AMINA S/P	55
AMINA S/R	55
AMINA S/T	55

ANTEA

ANTEA P/1	61
ANTEA P/3	61
ANTEA S/1	61
ANTEA S/3	61

ARIA

ARIA A	117
ARIA P/G	117
ARIA P/M	117
ARIA P/P	117

ASMARA

ASMARA S/1	248
ASMARA V/1	248

AURELIA

AURELIA S/1	248
AURELIA V/1	248

AZZURRA

AZZURRA S/1	248
AZZURRA V/1	248

BARBIE

BARBIE S/G	37
BARBIE S/P	37

BILBAO

BILBAO P/G	163
BILBAO P/M	163
BILBAO P/P	163

BLANCA

BLANCA S/P	41
------------	----

BONELLA

BONELLA S/G	45
BONELLA S/P	45

BRUNA

BRUNA S/G	49
BRUNA S/P	49

CAMILLA

CAMILLA A/M	279
CAMILLA A/P	279
CAMILLA L/P	279
CAMILLA P/M	279
CAMILLA P/P	279
CAMILLA S/G	279

CESIRA

CESIRA S/10	255
CESIRA S/11	255
CESIRA S/12	255
CESIRA S/3	255

CLEOFE

CLEOFE S/10	234
CLEOFE S/11	234
CLEOFE S/12	234
CLEOFE S/3	235
CLEOFE S/6	235

CORA

CORA S	215
--------	-----

INDICE INFORMAZIONI TECNICHE

DAFNE

DAFNE S/3G	19
DAFNE S/3P	19
DAFNE S/G	19
DAFNE S/P	19

DELIA

DELIA A	305
DELIA P/G	305
DELIA P/P	305
DELIA S	305

DIVA

DIVA L	75
DIVA S/G	75
DIVA S/P	75

DOHA

DOHA A/G	135
DOHA A/P	135
DOHA P/G	135
DOHA P/M	135
DOHA P/P	135

DUNA

DUNA P	33
--------	----

ELBA

ELBA S	219
--------	-----

EMILY

EMILY P	29
EMILY S	29

ESTER

ESTER S	219
---------	-----

FRIDA

FRIDA A/G	291
FRIDA A/P	291
FRIDA P/G	291
FRIDA P/M	291
FRIDA P/P	291

GISELLE

GISELLE P/G	157
GISELLE P/M	157
GISELLE P/P	157
GISELLE S	157

GRACE

GRACE P/G	123
GRACE P/M	123
GRACE P/P	123

GUYA

GUYA S/1	25
GUYA S/3	25
GUYA S/5	25

HELENA

HELENA S/1	13
HELENA S/3	13

IOLE

IOLE L	91
IOLE P/T	91
IOLE S/1	90
IOLE S/2	90
IOLE S/3	90

IRENE

IRENE P/G	151
IRENE P/M	151
IRENE P/P	151
IRENE S	151

ISOTTA

ISOTTA P/G	175
ISOTTA P/M	175
ISOTTA P/P	175
ISOTTA S	175

KRIZIA

KRIZIA P/G	69
KRIZIA P/M	69
KRIZIA P/P	69
KRIZIA P/S	69
KRIZIA S/2	68
KRIZIA S/G	68
KRIZIA S/M	68
KRIZIA S/P	68

LARA

LARA A/P	285
LARA P/G	285
LARA P/M	285
LARA P/P	285

LECCE

LECCE A/P	313
LECCE A/G	313
LECCE P/P	313
LECCE P/M	313

LUNA

LUNA P/G	169
LUNA P/M	169
LUNA P/P	169
LUNA S	169

MANILA

MANILA P/G	111
MANILA P/M	111
MANILA P/P	111

MELANIA

MELANIA P/G	107
MELANIA P/M	107
MELANIA P/P	107

MICHELA

MICHELA A/G	309
MICHELA A/P	309
MICHELA P/M	309
MICHELA P/P	309

NEREIDE

NEREIDE A	297
NEREIDE L	297
NEREIDE P/M	297
NEREIDE P/P	297
NEREIDE S/M	297

OLIMPIA

OLIMPIA P/G	145
OLIMPIA P/M	145
OLIMPIA P/P	145

PENELOPE

PENELOPE A/M	264
PENELOPE A/P	264
PENELOPE L	264
PENELOPE P/M	264
PENELOPE P/P	264
PENELOPE S/G	265
PENELOPE S/M	265

SFERA

SFERA S	225
SFERA S/10	225
SFERA S/6	225

SOLE

SOLE P/G	141
SOLE P/M	141
SOLE P/P	141
SOLE S	141

SUELO

SUELO PT	195
----------	-----

TARA

TARA L	203
TARA PT	203

TESSA

TESSA P/3	103
TESSA P/5	103

TILDE

TILDE PT	183
----------	-----

TOSCA

TOSCA P/1	99
TOSCA P/3	99
TOSCA P/4	99

TULLIA

TULLIA P/3	95
TULLIA P/4	95

VANDA

VANDA A	187
VANDA L	187
VANDA PT	187

VELIA

VELIA A	207
VELIA L	207
VELIA PT	207

VITA

VITA A	199
VITA L	199
VITA PT	199

YARA

YARA P/G	81
YARA P/M	81
YARA P/P	81
YARA S/G	81
YARA S/P	81

ZAIRA

ZAIRA L	179
ZAIRA PT	179

General Sales Conditions /

CONDIZIONI GENERALI DI VENDITA

CONDIZIONI GENERALI DI VENDITA

Le descrizioni e le illustrazioni dei prodotti devono intendersi a titolo indicativo. È vietata la riproduzione, la copia anche parziale e la diffusione di questo documento attraverso qualsiasi mezzo (telematico, fotocopia o altro) senza permesso scritto del proprietario. Pertanto la GEA LUCE si riserva il diritto di fare tutte le modifiche per migliorare il prodotto senza obbligo di preavviso. Non verranno accettati ritorni di merce se non preavvisati e da noi espressamente autorizzati. Porto Franco euro 150,00 (netti). Saranno addebitati euro 10,00 come contributo per spese di trasporto e imballo per ordini inferiori a euro 150,00 (netti). Non verrà addebitato nessun costo aggiuntivo per il contributo RAEE sostenuto dall'azienda. Per ogni controversia è competente il Foro di Foggia.

GENERAL SALES CONDITIONS

Strict accuracy of descriptions and illustrations of the products cannot be guaranteed. No part of this document may be reproduced or transmitted in any form, by any means (electronic, photocopying, recording or otherwise) without the prior written permission of the owner. There fore due to its policy of product improvement, GEALUCE reserves the right to make any changes without notice. No goods may be returned without previous GEA LUCE's written permission. All goods supplied ex factory. The RAEE costs will be hold from our company. All legal actions to take place under the jurisdiction of the Foggia Authorities.



GEA LUCE srl
Via Tardio Snc
71016 San Severo (Foggia)
T +39 0882 374954
F +39 0882 336161
info@gealuce.com
www.gealuce.com



Art Direction
Mario Cappelletto

Photo
Asolana Group
Archivio Gea Luce / Quasar

Print
Asolana Group
October 2020

Copyright © GEA LUCE Srl



gealuce.com